



ACCESSORIES CATALOGUE



Accessories

Contents

Cab, Sheet Metal & Electrical

Msc 4

Rubber Sections Msc 4

Door Handles Msc 5

Wiper Parts Msc 10

Mirrors Msc 19

Seats Msc 24

Gas Struts Msc 40

Lucas Beacons Msc 50

Work Lamps Msc 54

Trailer Lights Msc 60

Easyfit Wiring Msc 62

Marker Lamps Msc 64

LED Trailer Lights Msc 70

Pins & Sockets Msc 74

Trailer Jockey

Wheels & Parts Msc 76

Trailer Heads Msc 77

Tow Hitches Msc 78

Nuts & Bolts Msc 81

Suspension Msc 82

Mudguards Msc 83

Brake Shoes Msc 85

Brake Cables Msc 86

Bulbs Msc 90

Electrical Cable Msc 91

Terminals/Fuses Msc 95

Batteries & Accessories Msc 100

Relays Msc 108

Switches Msc 110

Fan Blowers Msc 119

Tractor Paint Msc 122

Brakes, Linkage & Hydraulics

Msc 124

Euro Brackets Msc 124

Top Links Msc 126

Top Link Components Msc 137

Stabilisers Msc 145

Clevis Components Msc 154

Linkage CBM Type Msc 156

Hydraulic Filters Msc 170

Quick Release Couplings Msc 172

Cooling

Msc 182

Radiator, Fuel & Oil Caps Msc 182

Fuel Pumps Msc 188

Fan Belts Msc 192

Bolts, Nuts & Bearings

Msc 198

High Tensile Steel Bolts Msc 198

Ball Bearings Msc 204

Garage Equipment

Msc 208

Universal Joints, PTO & Crossends

Msc 230



Rubber Sections

Weather Strip - Suits 3mm - 6mm Glass

1407-5 5 METRES

1407-10 10 METRES

1407-20 20 METRES

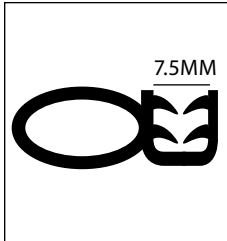

Weather Strip - Suits 2mm - 3mm Glass

2548-5 5 METRES

2548-10 10 METRES

2548-20 20 METRES

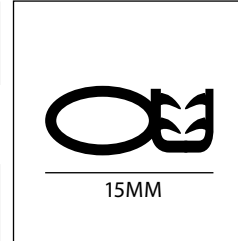

S Section Rubber

1888-5 5 METRES

1888-10 10 METRES

1888-20 20 METRES

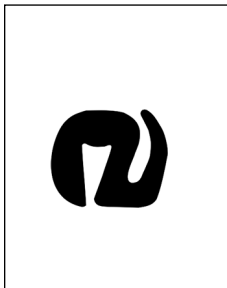

Vinyl Edge Trim - 0.7 - 2.5mm Glass / Panel

3984-5 5 METRES

3984-10 10 METRES

3984-20 20 METRES

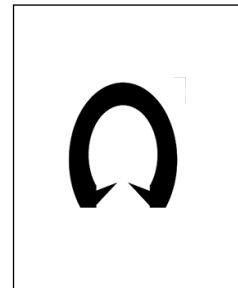

Weather Strip Beaded - Suits 4.8mm Glass

1773-5 5 METRES

1773-10 10 METRES

1773-20 20 METRES

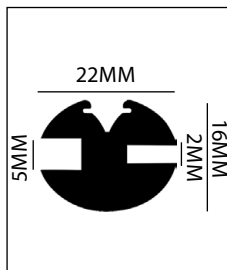

Weather Strip Beaded - Suits 6.4mm Glass

3097-5 5 METRES

3097-10 10 METRES

3097-20 20 METRES

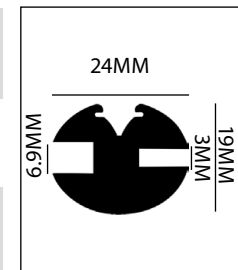

Filler Strips for Beaded Weather Strips

1774-5 5 METRES

1774-10 10 METRES

1774-20 20 METRES

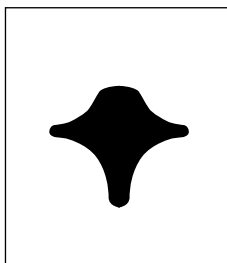

Draught Excluder Rubber - 1 - 3 mm

1285-5 5 METRES

1285-10 10 METRES

1285-20 20 METRES

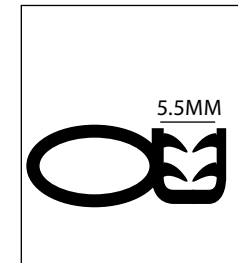

1427

Weather Strip Tool



Interior Door Handles

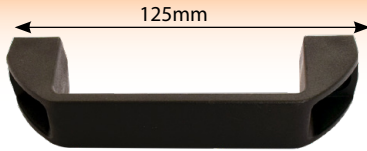

4322
Door Handle Interior

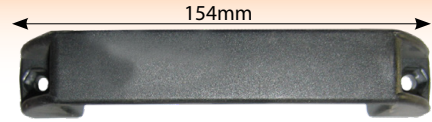

4323
Door Handle Interior Large

4571
Door Handle Inside
Tap On



4572
Door Handle - Inside
Allen Key



Door Handles

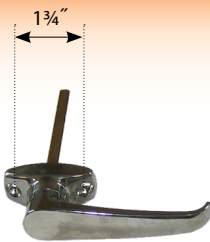

3982
Non Locking Plain
Handle 1 3/4"

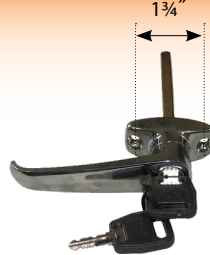

3983
Locking Handle
500's 1 3/4"

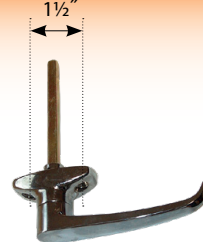

1770
Door Handle Non
Locking 1 1/2"

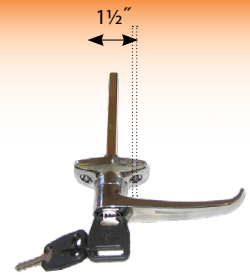

1288
Door Locking Handle
1 1/2"



4246
Door Handle 290
Sanki Outer



429983
Door Handle 4200
Outer LH & RH



4567
Door Handle 300's Outside
Spacer pack is 62842



62842
Spacer Pack 390 Door Handle
Door Handle is 4567



4317
Door Handle & Lock Ford
Super Q Cab Outside



6097
Door Handle 600
Outer LH & RH



61266
Door Handle 5400 6100
6200 8100 8200

Cab Door Handles

Ford



42025
Door Handle Outer Ford 40 Series
Suits TL & TS 60



42095
Door Handle Ford TSA MXU



3058
Door Locking Handle Ford
Q Cab

Fiat



7258
Door Handle Fiat Right Hand Outer
1180 1280 1380 1580 1880 580 680
780 880 880-5 980 55-90 60-90
65-90 70-90 80-90



7259
Door Handle Fiat Left Hand Outer
1180 1280 1380 1580 1880 580
680 780 880 880- 880-5 980 55-90
60-90 65-90 70-90 80-90

David Brown



2341
Door Handle David Brown
Q Cab Left Hand



2342
Door Handle David Brown
Q Cab Right Hand

John Deere



59455
Outer Door Handle John Deere
61 6900 LH & RH



59451
Push Pull Inner Door Handle John Deere
6000 10 20 30 Series Left Hand



59362
Rubber John Deere Outer 6000
7000 Door Handle
Up to serial no. 203054

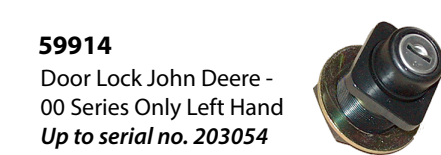

59914
Door Lock John Deere -
00 Series Only Left Hand
Up to serial no. 203054

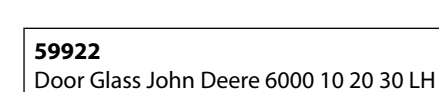

59922
Door Glass John Deere 6000 10 20 30 LH



4652
Door Handle Duncan
Outside



C3001
Door Handle Cab Craft LH
RH Inner



C3002
Door Handle Cab
Craft Outer

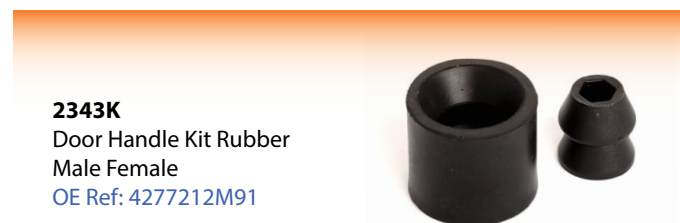

2343K
Door Handle Kit Rubber
Male Female
OE Ref: 4277212M91



51252
Door Retainer Nylon
Heavy Duty

Door Locks

Massey Ferguson

1670820

Door Lock 590 Right Hand



1670819

Door Lock 590 Left Hand

3301855

Door Lock 600 Right Hand Inner

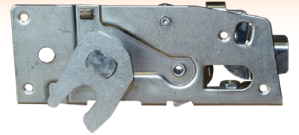

6098

Door Lock 600 Inner Left Hand

6698

Door Lock 3000 Right Hand



6699

Door Lock 3000 Left Hand

3718

Door Lock Q Cab Sankey Right Hand



3719

Door Lock Q Cab Sankey Left Hand

New Holland & Ford

42106

Door Lock TM TL TS TLA
- Left Hand



42146

Door Lock
TSA Left
Hand

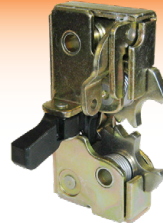

4315

Door Lock Super Q
Cab Left Hand Inner



43885

Door Lock Ford TM TL
TSLA Right Hand

41338 - Door Cable TL TM TS

4316

Door Lock Super Q
Cab Right Hand Inner

Landini

6362

Door Lock Landini Blizzard Left Hand



6363

Door Lock for Landini Blizzard Right Hand

Fiat

7256

Door Lock Fiat Right Hand Inner



7257

Door Lock Fiat Left Hand Inner

3191

Door Lock Right Hand for Cab

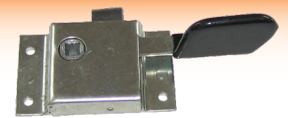

3202

Door Lock Left Hand for Cab

Door Slam Locks

1655

Door Slam Lock Left Hand

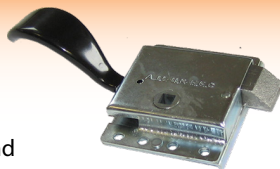

1769

Door Slam Lock Left Hand

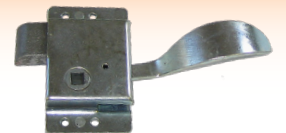

1718

Door Slam Lock Cab Right Hand

1768

Door Slam Lock Right Hand

1771

Door Slam Lock Duncan



S4040

Door Slam Lock Ford Inner 2000 2600
3000 3600 4000 4100 4600 5000 5600
6600 7000 7600(3058 outer/4571 inner)

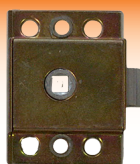

2213

Door Slam Lock David Brown
Left Hand No Safety Catch

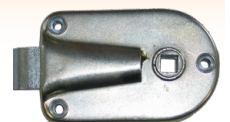

2212

Door Slam Lock David Brown
Right Hand No Safety Catch

Window Handles



2798
Window Handle



3787
Side Window Handle Kit (Ratchet Positioned)

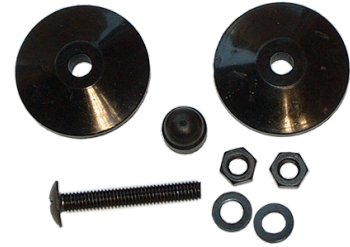

4507
Glazing Clamp

Glazing Clamp

Hinges



3779
Hinge 6" x 1/2" Straight



1100
Hinge Carrier 1/2' Weld on



4512
100mm Mild Steel Weld on Hinge



4513
120mm Mild Steel Weld on Hinge & Nipple

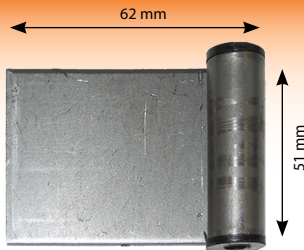

3190
Hinge Female / Male Bushed Lift Off RH

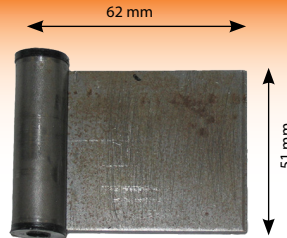

3189
Hinge Female / Male Bushed Lift Off LH

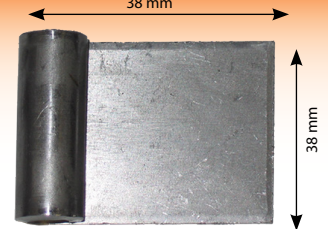

3186
Hinge Female Lift Off



3188
Hinge Male Bushed Lift Off RH

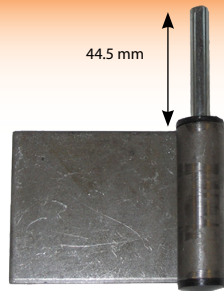

3187
Hinge Male Bushed Lift Off LH

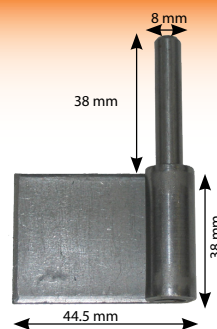

3184
Hinge Male Lift Off LH

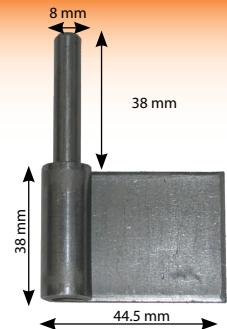

3185
Hinge Male Lift Off RH

Cab Parts

Alarms

Yellow Wire to Disable Alarm When Lights are turned on



51083
Reversing Alarm
Buzzer 12v - 24v



51986
Reversing Alarm Buzzer
Waterproof 12v 24v



51179
Reversing Alarm Buzzer
Waterproof 12 24v

Buzzers

51005
Buzzer 6-24 Volt



1956
Buzzer 12v Mini



Bonnet Catches

2580
Bonnet Catch 5"



2581
Bonnet Catch 2 1/2"



Wheel Spinners



1197
Wheel Spinner Straight - Flat
Steering Wheel



1148
Wheel Spinner 15°











4029
Wheel Spinner 30°

Disc Holder

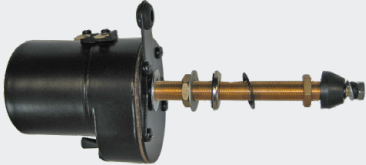
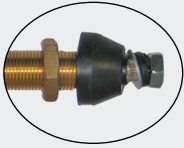

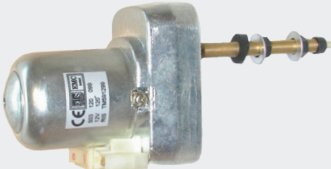
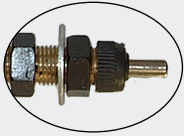
1772
Tax Disc and
Licence Holder
Chrome

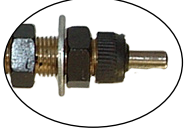
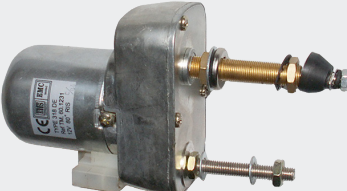
Wiper Motors

<p>4195</p>	<p>12 Volt 90 Degree with Arm & Blade Shaft Length - 58mm</p>	 <p>Motor = 3859</p>	
<p>3859</p>	<p>12 Volt 90 Degree Small Tapered Shaft with Switch Shaft length - 58mm</p>	 <p>Kit = 4195</p>	
<p>2494</p>	<p>12 Volt 105 Degree Small Taper</p>		
<p>2493</p>	<p>12 Volt 85 Degree Small Tapered</p>		
<p>41656</p>	<p>12 Volt 120 Degree Straight Single Spin Shaft Length - 99mm</p>		
<p>51045</p>	<p>12 Volt 110 Degree Short Stem Straight Shaft Length 46mm Arm is 4296</p>		
<p>2491</p>	<p>12 Volt 80 Degree Small Tapered Shaft Shaft Length - 58mm</p>		

Wiper Motors

<p>4169</p>	<p>Wiper Motor Kit 12 Volt 110° with Arm & Blade Shaft Length=58mm</p>	
<p>2492</p>	<p>12 Volt 110 Degree Small Tapered Shaft Shaft Length - 58mm</p>	
<p>51025</p>	<p>Case 12V 135 Degree s Small Tapered Shaft Shaft Length - 34mm</p>	
<p>51260</p>	<p>12 Volt 90 Degree Small Tapered Shaft Includes Cover & Switch Shaft Length - 48mm</p>	
<p>1008</p>	<p>12 Volt 110° Small Tapered Shaft with switch Shaft Length - 58mm</p>	<p>Lucas-TVS Auto Electrical Equipment</p> <p>Kit = 4169</p> 
<p>3860</p>	<p>24 Volt 90° Small Tapered Shaft with switch Shaft Length - 58mm</p>	
<p>51006</p>	<p>12V 95 Degree Large Tapered Shaft - Shaft Length 80mm Suits David Brown Tractors</p>	

WIPER MOTORS SUITABLE FOR JOHN DEERE TRACTORS

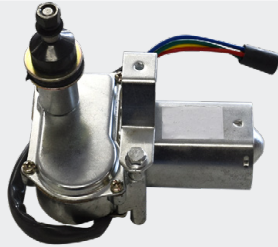
Part No.	Models/Description	OE Reference	
58714	John Deere 40 50 Series 12V SG2 Left Hand	AL34846	
51027	John Deere SG2 12V 90 Degree SG2 Right Hand	AL34843	
59283	Wiper Motor John Deere 6000 Series	RE151494	

WIPER MOTORS SUITABLE FOR NEW HOLLAND & FORD TRACTORS

Part No.	Models/Description	OE Reference	
1563	Wiper Motor Ford Super Q TW5 TW35 10	83961569	
43843	Wiper Motor TM Series	82016930	
43930	Wiper Motor T6 T7 T6010 T6080 T7030 - T7060 TS100A - TS135A	82032050	

WIPER MOTORS SUITABLE FOR MASSEY FERGUSON TRACTORS

Part No.	Models/Description	OE Reference	
6671	300 Series 12V 115 Degree Small Tapered Shaft (Shaft length 78mm)	3900628M2	
6645	Wiper Motor 390 12V 105 Degree Large Tapered Shaft Shaft length 33mm	3901103M2	
51059	Wiper Motor 390 398 105 Degree Shaft Length 48mm	3597357M92	 <p>Arm = 2207 Blade = 1619</p>
63240	Wiper Motor Front 54s 42s 43s	3812438M91	
63268	Wiper Motor 42 Series	3808786M92	
51061	Wiper Motor 5400 6100 6200 6400 7400 8100 Also Fits 8200 - For Rear Window	3715610M1	 <p>Arm = 2207 Blade = 1619</p>
64411	Wiper Motor 6235 6245 6255 6260 6265 6270 6280 6290	3777698M92	

WIPER MOTORS SUITABLE FOR DEUTZ TRACTORS

Part No.	Models	OE Reference	
54234	WIPER MOTOR DEUTZ AGROTRON AGROFARM AGROPLUS	04413192	
54264	WIPER MOTOR DEUTZ AGROPRIMA AGROXTRA DX3SC	04390385	
54265	WIPER MOTOR DEUTZ AGROPRIMA AGROXTRA DX4 DX6 12V	01175799	
54268	DEUTZ 07 07C DX	01175958	
54267	WIPER MOTOR DEUTZ AGROSTAR AGROSTAR FREISICHT AGROSTAR TG	04398897	

WIPER MOTORS SUITABLE FOR CASE TRACTORS

52956	Case 40 43 44 45 56 95 12V	1535097C1	
52955	Case BD Series	1089015R1	
54268	Case 433 533 633 733 833 933 940 743 844 745S 1056 856 956 Deutz 07 07C DX John Deere 40 50 Series	01175958	
51026	Wiper Motor Case 12V 115 Degrees Small Tapered Shaft Shaft Length 34mm		

Window Washer Parts

51080
Window Washer 2.2 Ltr 12V
220 long x 153 high x 75mm wide

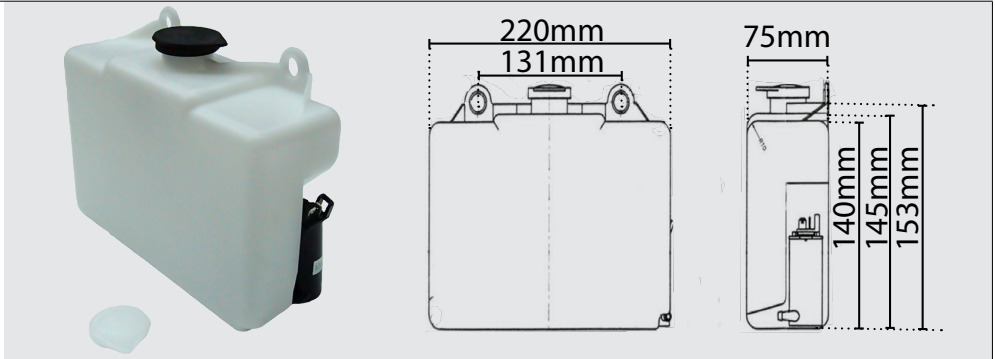

51607
Window Washer 12V
138 long x 125 high x 97mm wide

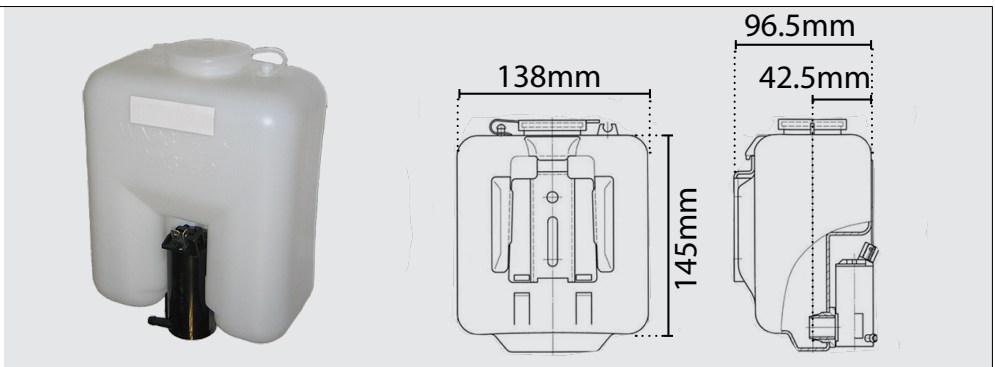

51079
Window Washer Kit



51078
Window Washer T Piece 4 x 6mm



WIPER ARMS

Part No	Motor Type	Description	Length		Image
			Inches	mm	
4296	Straight Shaft	Wiper Arm	18"	457.2	
2207	Small Tapered Shaft	Adjustable Wiper Arm Kits - 4195, 4169	15½" - 20½"	Min - 400 Max - 520	
1897	Small Tapered Shaft	Adjustable Parallel Arm Blade -1619 Blade -53769	15" - 19½"	Min - 380 Max - 500	
51497	Small Tapered Shaft	Adjustable Wiper Arm	15½" - 19½"	Min - 400 Max - 495	
51008	Large Tapered	Wiper Arm MF 600 Series	18½"	480	
2870	Large Splined	Wiper Arm Ford Super Q & Q Cab Blade -2837	17"	431.8	
4894	Large Tapered	Adjustable Wiper Arm - Large Hole	15½" - 19½"	Min - 400 Max - 500	

WIPER BLADES

Part No	Description	Length		Image
		Inches	mm	
2206	Wiper Blade suits 1008 Motor Kits - 4195, 4169	15½"	400	
2246	Wiper Blade	17.7"	450	
4685	Wiper Blade	24"	609.6	
1619	Wiper Blade to Suit Wiper Arm - 1897	20"	508	
6753	Suits MF 600/3000'S	23.6"	600	
61941	MF 42/43/61/62/81/82' Series 5400 6400 7400 Case Ford DB Fiat Deutz JD Leyland	20"	508	
2837	Ford Q & Super Q Cab John Deere 50's SG2 Cab Wiper Arm- 2870	19½"	500	
404895	40 TS TM M T6 T7 T6000 T7000 Adaptor - 409635	21.6"	550	
51009	Case XL	25.5"	650	
62039	Front Wiper Blade John Deere 6000/10/20 Front and Rear for 50HX	23.6"	600	
59803	Rear Wiper Blade John Deere 6000/10/20	19½"	500	
780048	Wiper Blade Renault TS/TX	27.5"	700	
53769	Wiper Blade suits 1897 Arm	23.6"	600	

Cab Parts

EXTRACTOR FAN

4877

Extractor Fan C/O Switch



HEATER 12V 3 SPEED

4876

262mm Wide x 195mm High x 241mm Depth



4879

Shut off Valve 16mm



61184

Knob for Tractor Cab Heater



HEATER HOSE

Heater Hose - 1/2"

2467-5 5 METRES

2467-10 10 METRES

2467-20 20 METRES



Heater Hose - 5/8"

4529-5 5 METRES

4529-10 10 METRES

4529-20 20 METRES



Heater Hose - 3/4"

51886-5 5 METRES

51886-10 10 METRES

51886-20 20 METRES



RUBBER HOSE

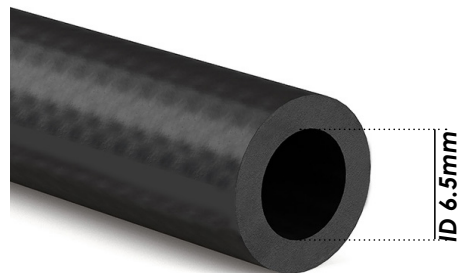

55377 10 METRES 1/4

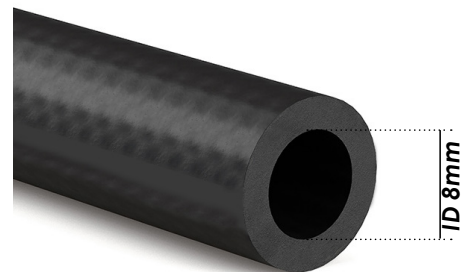

55378 10 METRES 5/16 (8mm)

Complete Mirrors

Massey Ferguson



62615
Mirror Complete Telescopic
5400 6400 LH RH
Glass to suit is 41101GL
313mm x 224mm



1506
Mirror 3000s
320 x 220mm



62086
Mirror Round with Arm To
Suit Exhaust Pipe



62103
Mirror Round R-View & Clamp
kit For Exhaust Pipe



6499000
Right Hand Complete Mirror 600
235x170mm
6499001 Left Hand



59656
Mirror Rear View 180; Wide Angle Small
220x110mm



59657
Mirror Rear View 180; Wide Angle Large
280X160mm

Same



6490000
Right Hand Complete Mirror Same Deutz 180x236mm
[OE Ref: 092341474](#)
6490001 Left Hand



1190
Mirror 340 x 220mm



1241
Mirror For Interior - 147mm x 97mm
Super Q



1535
Flat Mirror 355mm x 165mm

Ford



2042
Mirror Ford 7840 Convex Also suits Q Cab 257x157mm
Glass to suit is 2042GL



2325
Mirror Ford Q Cab 10 1/2 x 6 3/4
Glass to suit is 2325GL



41101
Rear View Mirror Ford 60/70/M/TM/TR/TS's
Glass to suit is 41101GL
Mirror Arm is 42098



41102
Rear View Mirror Ford 8160-8970 M TM TR TS
Glass to suit is 2042GL
Mirror Arms To Suit are 409679 + 409680



409928
Mirror Ford 40 TS 81 - 8560
Rear View
Suits - 409691 & 409690
Glass to suit is 2042GL



409690
Left Hand Rear View Complete Mirror Ford 40 TS 81-85 60
OE Ref: 82007669
409691 - Right Hand
OE Ref: 82007667
Mirror to Suit is 409928
Glass is 2042GL

Småt Nord Mirror

6480025
Mirror 237 x 180mm
16mm 18mm 20mm Clamps
Ford 7840 Convex Suits Q Cab
Fiat Deutz Same Lamborgini
Massey Ferguson



6854001
Mirror Complete Fiat Hitachi
180x236mm



6451000
Complete Mirror Fiat Right Hand
180x236mm



6451001
Complete Mirror Fiat Left Hand
180x236mm

John Deere

<p>59901 Mirror John Deere 10 20 6000 Rear View <i>Glass to suit is 59901GL</i></p>	<p>6398025 Mirror John Deere Replacement</p>	<p>1254 Mirror Head 177mm x 127mm <i>Glass to suit is 1254GL</i></p>	<p>6551001 Mirror Assembly Complete - 215mm</p>
<p>4238 Mirror 13 1/2 x 7 1/2' <i>Glass to suit is 4238GL</i></p>	<p>53155 Complete Kit Including: mirrors, switches & installation cables <i>Mirror Size - 305 x 215mm</i></p>	<p>53748 Heated Mirror with Electrical Adjustment OE Ref: 4288898M91</p>	<p>54168 2 Mirror Control Switch</p>

Mirror Glass

<p>4238GL Glass Replacement for 4238</p>	<p>41101GL Massey Ferguson 54/64/62 series <i>Suits to 62615</i> <i>Mirror 313mm x 224mm</i></p>	<p>1254GL Mirror Glass <i>178 x 127mm</i></p>	<p>59690 Mirror Glass Deutz Steyr Fendt 700 800 900's <i>Size 300 x 214 Convex Single</i> <i>5 per box</i></p>
<p>1192GL Mirror Glass for 1192 <i>374 x 190mm</i></p>	<p>2325GL Mirror Glass Ford Q Cab for 2325 <i>253 x 150 mm</i> <i>2042GL is Convex</i></p>	<p>2042GL Mirror Glass Convex for 2042 Ford 40's</p>	<p>59901GL Mirror Glass John Deere 10 20 60 R/View PAIR <i>281 x 201 mm</i></p>

Ford



409616

Telescopic Rear View Mirror Arm Ford TM115-165 Left Hand
(99-02) 8160-8560 (95-00) TS90-115 (97-03)

OE Ref: 82014589

Mirror to suit is 41101

409617 Right Hand

OE Ref: 82014588



409679

Mirror Arm Ford 60 TM TS Left Hand

OE Ref: 82014839

Mirror to suit is 41102

409680 Right Hand

OE Ref: 82014838



42098

Mirror Arm TSA T Series Right Hand

OE Ref: 87314382 RH

Mirror = 41101 Glass 41101GL

42099 Left Hand

OE Ref: 87314381 LH



6550

Mirror Arm 300 Right Hand / Left Hand D Headed

OE Ref: 3901343M91



62838

Mirror Arm Right Hand 41 42 61 81

OE Ref: 3806613M93

62839

Mirror Arm Left Hand 41 42 61 81

OE Ref: 3806612M93

Mirror Arms

- 2590** Mirror Arm 8"
- 2589** Mirror Arm 12"
- 2591** Mirror Arm 16"



John Deere



59796
Telescopic Mirror Arm John Deere 10 20 6000's Left Hand
OE Ref: [AL77483](#)

59800 Right Hand
OE Ref: [AL77484](#)
Mirror to suit is 59901



59797
Telescopic Mirror Arm Kit John Deere 6000 Left Hand
Mirror to suit is 59901
Arm is 59796
OE Ref: [AL80126](#)

59903 Right Hand OE Ref: [AL80127](#)
Mirror to suit is 59901
Arm is 59800

Renault



780066
Mirror Arm Renault TS-TX Left Hand
OE Ref: [6005007238](#)

780067 Right Hand
OE Ref: [6005007243](#)

SEATS

51606 BLUE SEAT
WITH ANGLE ADJUSTMENT

51738 BLACK SEAT
WITH ANGLE ADJUSTMENT

- Heavy duty vinyl covered molded cushions
- Adjustable weight suspension from 50kg - 136kg
- Height Adjustment
- Fore Aft Slide Adjustment
- Heavy steel base with multiple hole mounting pattern



51874
BLUE SEAT
WITH ANGLE ADJUSTMENT

51737
BLACK SEAT WITH SLIDING BASE

51805
BLUE SEAT WITH SLIDING BASE

- Heavy duty vinyl covered molded cushions
- Adjustable weight suspension, 50kg - 136kg
- Height Adjustment
- Fore Aft Slide Adjustment
- Heavy steel base with multiple hole mounting pattern

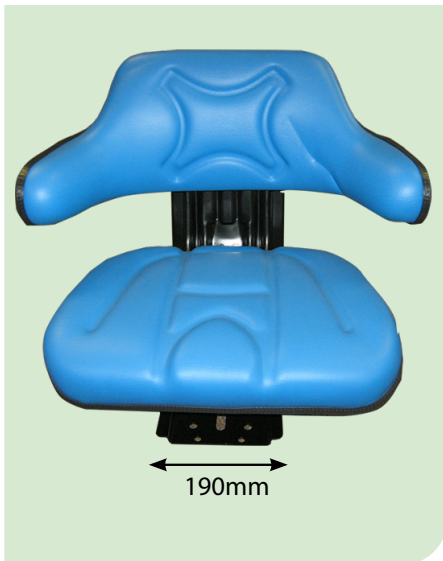

54317 - Back Cushion To Suit 51737
54318 - Base Cushion To Suit 51737

54323 - Back Cushion To Suit 51805
54322 - Base Cushion To Suit 51805

62957 Seat Riser Massey Ferguson 35 135

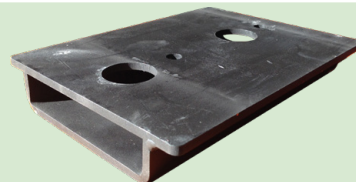

53850
SEAT - BLACK

- Heavy duty vinyl covered molded cushions
- Flat Back
- Sliding Base



53851
Replacement
Base Cushion

53852
Replacement
Back Cushion

52845 SCISSOR SUSPENSION SEAT

Foldable Armrest Scissor Suspension

Base 230mm Wide
330mm Deep

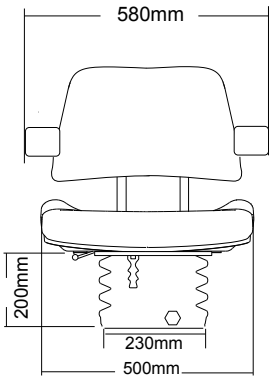

51803

SEAT WITH FOLDABLE ARMRESTS
AND REAR SUSPENSION

- Black hard wearing cloth fabric
- Fore Aft Slide Adjustment
- Adjustable weight from 50kg - 136kg

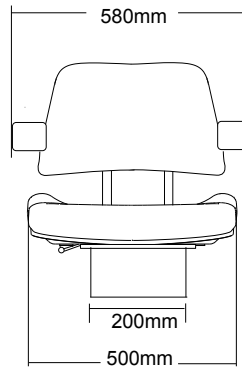

2195

**RIGHT HAND SIDE ARM
REST FOR GRAMMER SEAT**

- Landini, John Deere, Massey
Ferguson



53757

Arm Rest
Suits 51803



NEW 53923

DELUXE MECHANICAL SEAT



Weight Adjustment

Height Adjustment

Adjustable Armrest Angle

Adjustable Head Rest

Back Recline Adjustment

Hard Wearing Cloth Fabric

Fore Aft Slide Adjustment

Seat Belt Included

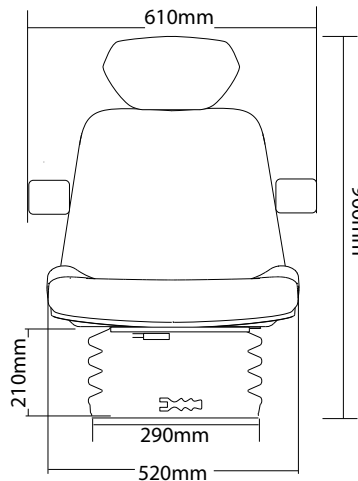

Base Front

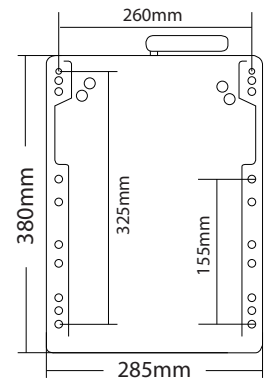

53764 MECHANICAL SEAT WITH COMPACT BASE



- 1 Double depth comfort Fabriform® cushions for that legendary Sears comfort
- 2 Fold up arm rests with substantial foam padding improving comfort
- 3 Weight adjustment indicator
- 4 Weight adjust control
- 5 Height adjust control
- 6 Fore/aft slide control
- 7 Mechanical suspension

908 , Sears seat part No. [SA20459.400](#)



SPECIFICATIONS

Double depth Fabriform® comfort cushions

Weight adjustment 30-130kg

Height adjustment 80mm

Slide travel 160mm

Moulded suspension cover

Vibration performance to ISO 7096

Armrests with tilt up adjustment

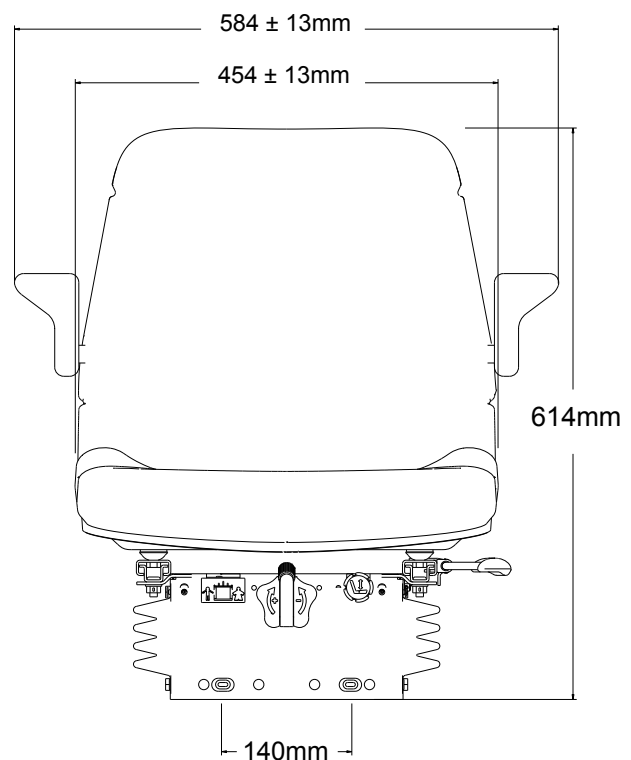

53765 AIR SEAT WITH COMPACT BASE



- 1 Double depth comfort Fabriform® cushions for that legendary Sears comfort
- 2 Fold up arm rests with substantial foam padding improving comfort
- 3 Height adjustment indicator
- 4 Low natural frequency Airide® suspension -air valve Adjust switch
- 5 Height/weight adjust control
- 6 Fore/aft slide control

930 , Sears seat part No. [SA20442.400](#)

<p>53883 Compressor Service Kit 12V Suits 53765 53766 53767</p>		<p>53818 Seat Adaptor Fixing Plate</p>
<p>53884 Air Spring Service Kit Suits 53765 53766 53767</p>		<p>54960 Height Adjuster Switch OE Ref:S14268.901</p>

SPECIFICATIONS

Double depth Fabriform® comfort cushions

Weight adjustment 30-130kg

Height adjustment 80mm

Slide travel 160mm

Moulded suspension cover

Vibration performance to ISO 7096

Armrests with tilt up adjustment

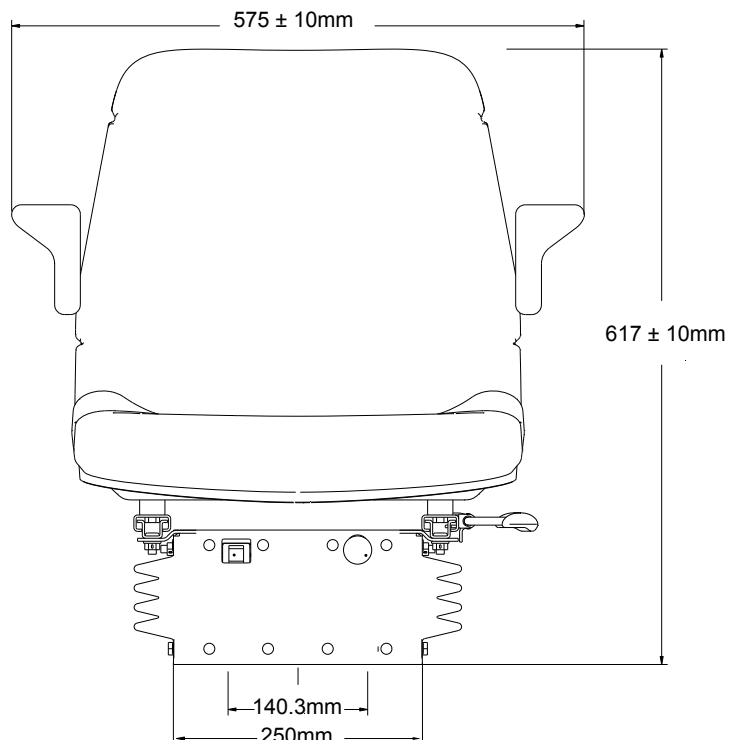



- 1 Ergonomically sculptured back support for full range of movement
- 2 Double depth comfort Fabriform® cushions for that legendary Sears comfort
- 3 Low natural frequency Airide® suspension -air valve adjust switch
- 4 Slide adjust control switch
- 5 Swivel 24° rotational adjustment left and right with lock in, lock out, free swivel facility. Making it easier when driving, getting in and out of the seat or using a rear attachment
- 6 Horizontal isolator for reduction in vibration when traveling at speed or when towing implements
- 7 Adjustable backrest angle provides customised comfort preventing damage from bad posture.
- 8 Fold up arm rests with height adjustment featuring substantial foam padding improving comfort when turning in the seat
- 9 Lumbar support lever

3045 , Sears seat part No. [SA24117.400](#)

53883 Compressor Service Kit 12V	53884 Air Spring Service Kit
53928 Operator Presence Switch Service Kit	54960 Height Adjuster Switch OE Ref:S14268.901

SPECIFICATIONS

- Replaceable double depth Fabriform® comfort cushions
- Height adjustment 76mm
- Back angle fully adjustable
- Automatic height & weight adjustment 50 -150kg
- Suspension stroke 80mm
- Horizontal isolator fully integrated, sprung & Duo® Damped
- Armrests with height & tilt up adjustment
- Slide travel 160mm
- Moulded suspension cover
- Vibration performance to ISO 7096
- Swivel adjustment 24 deg

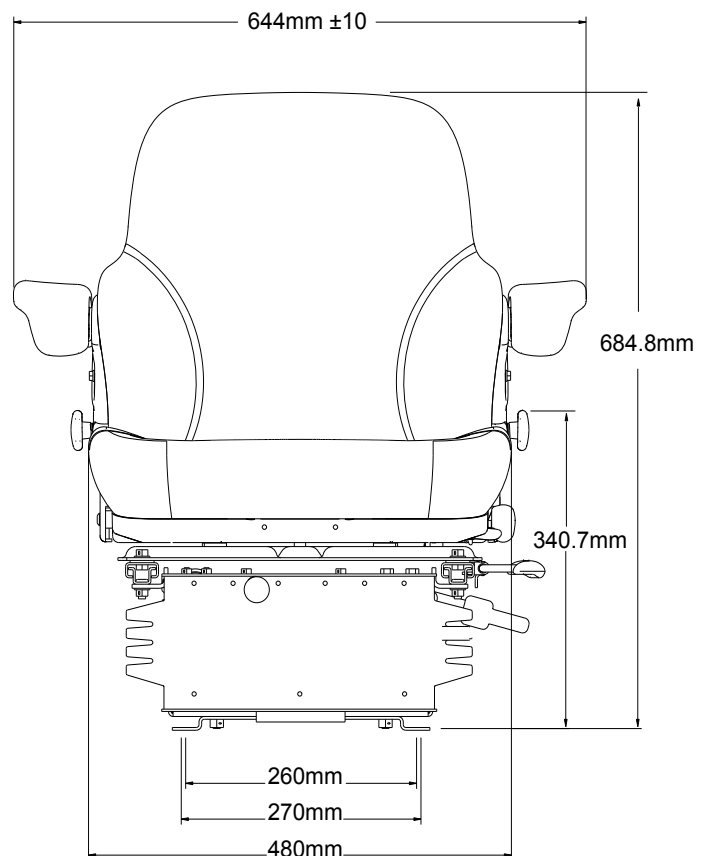



D5565A , Sears seat part No. SA30582.400

- 1 Adjustable backrest height provides customised comfort preventing damage from bad posture
- 2 Ergonomically sculptured back support for full range of movement
- 3 Fully adjustable armrests designed for easy angle adjustment on the move. These fully fold up & feature substantial foam padding for improved comfort when turning in the seat
- 4 Seat cushion extension 60mm (2 1/4") in 5 steps providing thigh support whatever your height
- 5 Swivel 24° rotational adjustment left and right with lock in, lock out, free swivel facility. Making it easier when driving, getting in and out of the seat or using a rear attachment
- 6 Seat cushion angle adjustment reduces pressure on the back of the knees
- 7 Low natural frequency Airide® suspension
- 8 Slide travel range - 200mm Roller slides for smooth seat positioning
- 9 Infinite seat back angle adjustment
- 10 Armrest mounted air valve switch for simple and accurate finger tip control
- 11 Electric air lumbar support - the air lumbar support moulds itself to your back, quickly and exactly

53883
Compressor Service Kit 12V

53884
Air Spring Service Kit

SPECIFICATIONS

- Back recline adjustment
- Fabric cushions (pour in place)
- Integrated backrest extension
- Lumbar - electric
- Seat cushion length adj
- Seat cushion angle adj
- Low Frequency Pneumatic (12v)
- ARPS (auto ride position system)
- Fixed shock absorber
- Integrated fore/ aft isolator
- Armrests - tilt up, angle + height adj
- Swivel adjustment 24 deg
- Dlx fore/ aft slides 200mm travel
- Operator presence switch
- Document holder
- Supplied with multifix mounting kit
- Seat cushion width 560mm
- Width across armrests 645mm
- Seat Index Point SIP ---
- Weight Adjustment
- Height Adjustment

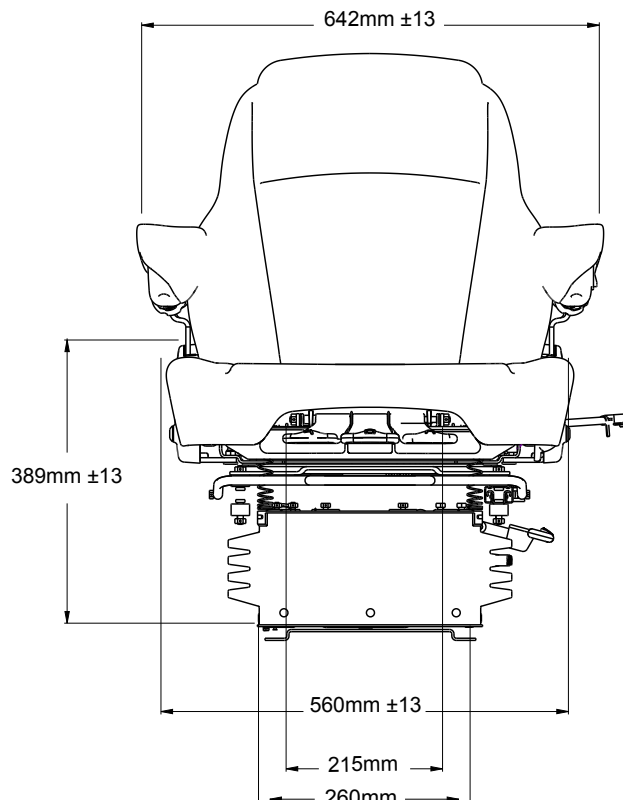

43683
Air Valve Switch for Height Adjustment In Arm Rest



REPLACEMENT PARTS SUITABLE FOR

GRAMMER SEATS

65111

Grammer Fabric Cushion Air Seat
Left & Right Tilt

OE Ref: 4374058M92



KEY FEATURES

Air suspension	Swivel (0° to 360°)
Weight adjustment range	Retractable seat belt
Fore/aft adjustment	Seat depth/tilt
Height adjustment	Adjustable or foldable armrests
Mechanical Lumbar support	Operator presence switch

AIR SPRING MSG93

55166

OE Ref: 1159779



AIR SPRING MSG95/97

55165

Air Spring Grammer
MSG95/97

OE Ref: 1137352



AIR SPRING KIT MSG/95/97

55164

OE Ref: 1081314



AIR HOSE KIT MSG95/97A

55163

OE Ref: 1096565



ROLLERS

55147	Roller - MSG95 MSG97 OE Ref: 129886
55148	White Roller Compacto Basic M MSG83/521 OE Ref: 107681
55146	Nylon Roller Grammer MSG95 OE Ref: 122704



PUSH BUTTON

55151
OE Ref: 105840



BUSHING MSG83/93/85

55145
OE Ref: 116010



WEAR PARTS KIT MSG95

55167
OE Ref: 1096585

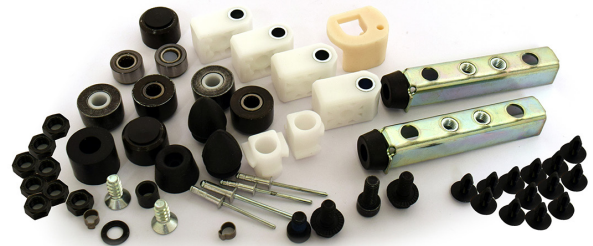

REPLACEMENT PARTS SUITABLE FOR

GRAMMER SEATS

ARM RESTS



MSG95AL/741 80 X 380mm

55155 Left Hand

OE Ref: 1026778

55152 Right Hand

OE Ref: 1026779



ARM REST 60 X 260

55168 Left Hand

OE Ref: 1100875

2195 Right Hand

OE Ref: 3540588M91



MSG83/721 65 x 270mm

55160 Left Hand

OE Ref: 1096328

55161 Right Hand

OE Ref: 1100875

ADJUSTMENT



COMPACTO BASICS MSG83/511

Adjustment Rail Set Level

55144 Left Side

OE Ref: 140733

55143 Right Side

OE Ref: 140927

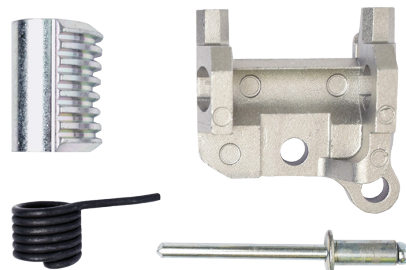

BACK ADJUSTMENT

DS85H/90LS95H/90

55157

Seat Grammer Adjustment Back

OE Ref: 139255

SHOCK ABSORBERS

55139	MSG95AL MSG97AL OE REF: 1303711
55140	MSG83/93/LS95/DS50 OE REF: 136195
55142	DS 20/D3H DS44/2 DS44/2 DS44/8 170-290mm OE REF: 114284
55141	DS85 MSG85 OE REF: 118576
580009	Grammer Maximo Comfort MSG95G/731 OE Ref: AL156144

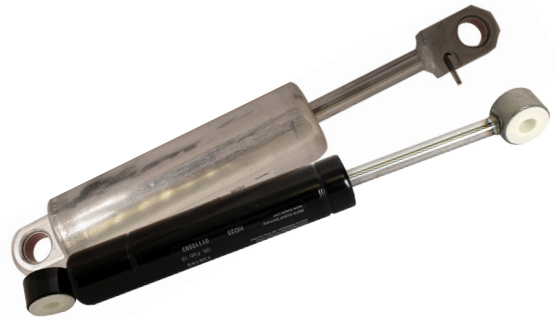

55159

Grammer Air Seat Compressor
12V MSG95 MSG97
OE Ref: 130670



55162

Seat Cushion Grammer
MSG83/721 MSG85/721
MSG95G/721
OE Ref: 141497



55156

Height Adjustment Control
Unit Grammer MSG95/97G
OE Ref: 132146



55154

Back Extension Grammer
MSG83/511 PVA
OE Ref: 1072516



55149

Air Valve Grammer Weight
Adjustment MSG93
OE Ref: 1159746



55150

Fork Seat Grammer Maxima
Basic MSG85/721
OE Ref: 113974

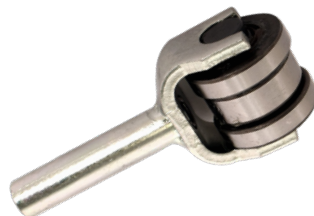

55153

Back Extension Grammer
MSG95G/721 Black
OE Ref: 140659



MASSEY FERGUSON

61808



Seat Kit Complete 35 35X 135
6993 x 1 61629 x 1 891870 x 1

891870



Seat Pan 35 35X 65 135 165
Bucket Type Red Also fits 185
188 240 265 290 Also fits TE20
TEA20 TED20 TEF20 TO20 T20

61629



Seat Lower Bracket
Assembly 35 35X 135

61975



Seat Hinge for 35 135 Seat

6993



Seat Cushion & Back Rest Kit
35 135

61530



Cover to Suit 6742
Backrest

61630



Seat to Spring Bumper 35
35X 135

1894548

Spring Seat

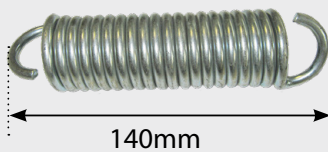

61632



Seat to Hinge Pin 35 35X 7 1/2" Long

61633



Seat to Hinge Pin 35 35X (6 7/8" Long)

FIAT

41768

Seat Passenger
Fiat New Holland
90



FORK LIFT SEAT

3107 Seat Fork Lift

Slide Base Width Adjustable
Minimum = 200mm
Maximum = 350mm



VINTAGE TRACTORS

MASSEY FERGUSON

61499

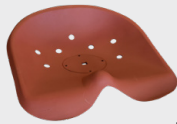

Seat Pan 20D TVO
9 Hole

61834



Seat Cushion 20D
- Black

7962



Seat Spring TE 20 TEA 20
TED 20 TEF 20

52844

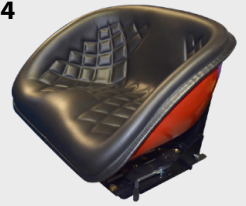

Base=200mm
Seat Bucket
Deluxe Red

FORDSON

51565



Stud for Bucket Seat
Nut

48825



Seat Spring Fordson N's
NAA/2000/8N/800

MAJOR

41329

Seat Cushion & Back Rest
Kit for Major
Has hump in cushion

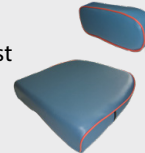

41329F

Seat Cushion &
Back Rest Kit for
Major
This is Flat



41570



Seat Pan Fordson
Major - 22 Hole

DEXTA

48824



Seat Ford N's - 6 Holes
NAA 2000 8N 800 900
48825 is Seat Spring

41328

Seat Cushion & Back Rest
Kit for Dexta



41328F

Seat Cushion & Back Rest
Kit for Dexta
Flat



41602

Seat Pan Ford Super
Dexta



41628

Seat Bracket
Fordson Dexta

FORD



41566

Seat Ford 2000 - 7000



Base=110mm

41621

Seat Pan Ford 2000 - 7000
4100 5100 Seat is 41566



41904

Seat Cushion Ford with
Logo Red



41903

Seat Cushion Ford
with Logo Blue

JOHN DEERE



4901
Seat John Deere
Tractor



59769
Seat John Deere
Gator



58827
Passenger Seat John Deere 5000s
OE Ref: LVB25717



51806
Seat Belt Automatic 2
Points

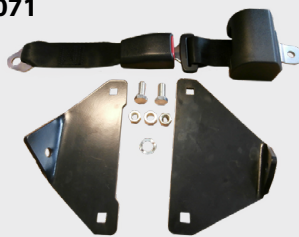

59071
Seat Belt Kit John Deere Passenger
Seat** Passenger Seat is 59902 **



59902
Seat Passenger
John Deere
Bracket
59115

DAVID BROWN



51531
Seat David Brown
Cushion & Back
Rest Kit



51532
Seat Cushion &
Back Rest Kit David
Brown R+W (Red
with White Trim)



51533
Seat Cushion &
Back Rest Kit David
Brown
(Red with Yellow
Trim)



53430
Seat Cover Back For
51531



53428
Seat Cover Back For
51532



52768R
Red Seat
David Brown
885 990 995 996
1210 1212
1410 1412



52768
Seat David Brown
885 990 995 996
1210 1212 1410
1412 Black



51535
Seat Cushion (Green) Nuffield

NUFFIELD

INTERNATIONAL

51534

Seat Cushion & Back Rest Kit (Intl)



52657

Seat Cushion IHC
Old Type Red



52658

Seat Cushion IHC
Old Type Black



Seat Covers

Tough 600 denier Polyester Waterproof Polyurethane backing

54850

Suits Grammer, Maximo, Dynamic Plus Seats

- ▶ Allows full linear movement of headrest / lumbar support
- ▶ Fitting is made easy due to the Velcro slots
- ▶ Held in place by specially designed tuck-in system & Velcro
- ▶ Allows access to armrests, controls & pocket at back of seat
- ▶ Separate parts allow for a perfect fit
- ▶ In the box: 4 pieces - 1 back cover, 1 base cover, 1 armrest & 1 headrest cover



54851

Universal Plant / Construction High Back Seat Cover

- ▶ One piece cover enables easy fitting
- ▶ Held in place by specially designed tuck-in system & elastic
- ▶ Velcro slots at side of cover allow access to armrests & seat adjuster controls
- ▶ Integrated headrest



54852

Universal standard seat cover for smaller tractor, plant & construction machinery seats.

- ▶ Access to armrest and headrest via Velcro slots
- ▶ Access for pocket on back of seat
- ▶ Elastic apron around base pulls cover firmly in place
- ▶ One piece cover allows for easy fitting



54853

Fits all variants of the Grammer Maximo, Primo and Compacto seats with lumbar support

- ▶ Separate lumbar support cover allows full adjustment for armrests
- ▶ Access to handbook pocket on back of seat
- ▶ Base of seat can be adjusted separately
- ▶ In the box: Three piece cover containing one base, one back and one lumbar support.



54854

Universal seat cover for larger tractor, plant & construction machinery seats.

- ▶ Access to armrest and headrest via Velcro slot
- ▶ Access for pocket on back of seat
- ▶ Elastic apron around base pulls cover firmly in place
- ▶ One piece cover allows for easy fitting
- ▶ Designed for vehicles with larger seats



Seat Covers

**Tough 600 denier Polyester
Waterproof Polyurethane backing**



54856

Tailored High Back Tractor / Plant Seat Cover

This cover is designed to fit the following vehicles:

- Grammer Actimo seats
- Sears high backed seats - 8500 & 7000 series
- KAB models ending in K4
- UNITEDSEATS models ending in C7 & ISRI: 6500KM/577

- ▶ Fitting is made easy due to the Velcro slots
- ▶ Held in place by specially designed tuck-in system and Velcro
- ▶ Allows access to armrests, controls & pocket at back of seat
- ▶ Separate parts allow for a perfect fit



51658

Seat Cover for Tractor



54855

Universal high back, large seat cover for tractor, plant and construction machinery with high back seats.

- ▶ Access to armrest and headrest via Velcro slot
- ▶ Access for pocket on back of seat
- ▶ Elastic apron base pulls cover firmly in place
- ▶ One piece cover allows for easy fitting
- ▶ Designed for vehicles with larger high back seats

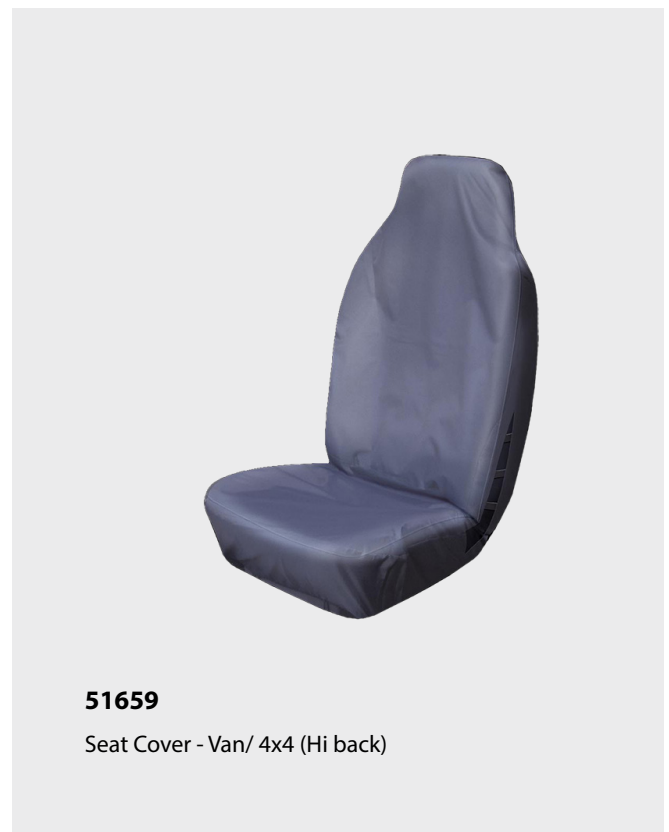

51659

Seat Cover - Van/ 4x4 (Hi back)

Gas Struts

Note:

Check Newton Rating Of Existing Gas Strut Before Ordering A Replacement. Using A Gas Strut With A Lower Or Higher Newton Rating Can Result In Damage Or Glass Breakage

41766

Application	Models
Bonnet	8160, 8260, 8360, 8560 TM115, TM120, TM125, TM130, TM135, TM140, TM150, TM155, TM165

Force (N)	Length (mm)	Ram (mm)	OE Ref
500	900	400	82019392

10mm

10mm

61285

Application	Models
Rear window	3050, 3060, 3065, 3070, 3075, 3080, 3085, 3090, 3095, 3115, 3120, 3125 3610, 3630, 3635, 3645, 3650, 3655, 3670, 3680, 3690

Force (N)	Length (mm)	Ram (mm)	OE Ref
250	785	350	3389556M2

M8

M8

59821

Application	Models
Rear window	50 Series 40 Series

Force (N)	Length (mm)	Ram (mm)	OE Ref
150	735	324	AL35675

M8

M8

1514

Application	Models
Rear window	40 Series

Force (N)	Length (mm)	Ram (mm)	OE Ref
150	730	320	AL33170

M8

M8

58905

Application	Models
Bonnet	6105R 6110R 6115R 6120R 6125R 6130R

Force (N)	Length (mm)	Ram (mm)	OE Ref
825	710	315	AL214868

A

B

43164

Application	Models
Bonnet	TS100, TS110, TS115, TS80, TS90

Force (N)	Length (mm)	Ram (mm)	OE Ref
450	685	300	82011092

A

10mm















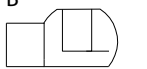



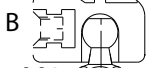

B

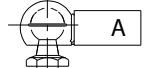
10mm

Gas Struts

Note:

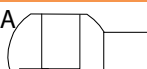







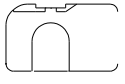
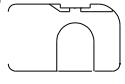

Check Newton Rating Of Existing Gas Strut Before Ordering A Replacement. Using A Gas Strut With A Lower Or Higher Newton Rating Can Result In Damage Or Glass Breakage

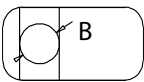
 <p>58904</p>	<table border="1"> <thead> <tr> <th>Application</th> <th>Models</th> </tr> </thead> <tbody> <tr> <td>Bonnet</td> <td>6130R 6140R 6145R 6150R 6155R 6175R 6195R 6215R 6130M 6135M 6140M 6145M 6150M 6155M 6170M 6175M</td> </tr> <tr> <th>Force (N)</th> <th>Length (mm)</th> <th>Ram (mm)</th> <th>OE Ref</th> </tr> <tr> <td>750</td> <td>620</td> <td>250</td> <td>AL215748</td> </tr> </tbody> </table>	Application	Models	Bonnet	6130R 6140R 6145R 6150R 6155R 6175R 6195R 6215R 6130M 6135M 6140M 6145M 6150M 6155M 6170M 6175M	Force (N)	Length (mm)	Ram (mm)	OE Ref	750	620	250	AL215748	 
Application	Models													
Bonnet	6130R 6140R 6145R 6150R 6155R 6175R 6195R 6215R 6130M 6135M 6140M 6145M 6150M 6155M 6170M 6175M													
Force (N)	Length (mm)	Ram (mm)	OE Ref											
750	620	250	AL215748											
 <p>780167</p>	<table border="1"> <thead> <tr> <th>Application</th> <th>Models</th> </tr> </thead> <tbody> <tr> <td>Rear window</td> <td>Renault 12-14 61-12 61-14 68-12 68-14 75-14 77-12 77-14 85-12 85-14 95-12 95-14 103-12 103-14 110-14</td> </tr> <tr> <th>Force (N)</th> <th>Length (mm)</th> <th>Ram (mm)</th> <th>OE Ref</th> </tr> <tr> <td>150</td> <td>605</td> <td>260</td> <td>7700002848</td> </tr> </tbody> </table>	Application	Models	Rear window	Renault 12-14 61-12 61-14 68-12 68-14 75-14 77-12 77-14 85-12 85-14 95-12 95-14 103-12 103-14 110-14	Force (N)	Length (mm)	Ram (mm)	OE Ref	150	605	260	7700002848	 <p>10mm</p>  <p>10mm</p>
Application	Models													
Rear window	Renault 12-14 61-12 61-14 68-12 68-14 75-14 77-12 77-14 85-12 85-14 95-12 95-14 103-12 103-14 110-14													
Force (N)	Length (mm)	Ram (mm)	OE Ref											
150	605	260	7700002848											
 <p>780163</p>	<table border="1"> <thead> <tr> <th>Application</th> <th>Models</th> </tr> </thead> <tbody> <tr> <td>Rear window</td> <td>Renault 781 781-4 781-4S 781S 851-4 851-4S 891 891-S 891-4S 951 951-4 981 981-4 981-4S 981S</td> </tr> <tr> <th>Force (N)</th> <th>Length (mm)</th> <th>Ram (mm)</th> <th>OE Ref</th> </tr> <tr> <td>400</td> <td>600</td> <td>265</td> <td>7700002849</td> </tr> </tbody> </table>	Application	Models	Rear window	Renault 781 781-4 781-4S 781S 851-4 851-4S 891 891-S 891-4S 951 951-4 981 981-4 981-4S 981S	Force (N)	Length (mm)	Ram (mm)	OE Ref	400	600	265	7700002849	 <p>8mm</p>  <p>8mm</p>
Application	Models													
Rear window	Renault 781 781-4 781-4S 781S 851-4 851-4S 891 891-S 891-4S 951 951-4 981 981-4 981-4S 981S													
Force (N)	Length (mm)	Ram (mm)	OE Ref											
400	600	265	7700002849											
 <p>61951</p>	<table border="1"> <thead> <tr> <th>Application</th> <th>Models</th> </tr> </thead> <tbody> <tr> <td>Rear window</td> <td>5425-5480 6110-6190 6235-6290 6445-6499 7465-7495 8110-8180 8210-8280</td> </tr> <tr> <th>Force (N)</th> <th>Length (mm)</th> <th>Ram (mm)</th> <th>OE Ref</th> </tr> <tr> <td>150</td> <td>585</td> <td>255</td> <td>3902140M1</td> </tr> </tbody> </table>	Application	Models	Rear window	5425-5480 6110-6190 6235-6290 6445-6499 7465-7495 8110-8180 8210-8280	Force (N)	Length (mm)	Ram (mm)	OE Ref	150	585	255	3902140M1	 <p>M8</p>  <p>M8</p>
Application	Models													
Rear window	5425-5480 6110-6190 6235-6290 6445-6499 7465-7495 8110-8180 8210-8280													
Force (N)	Length (mm)	Ram (mm)	OE Ref											
150	585	255	3902140M1											
 <p>407119</p>	<table border="1"> <thead> <tr> <th>Application</th> <th>Models</th> </tr> </thead> <tbody> <tr> <td>Rear window</td> <td>4635, 4835, 5635, 6635, 7635 5640, 6640, 7740, 7840, 8240, 8340 8160, 8260, 8360, 8560 L60, L65, L75, L85, L95 M100, M115, M135, M160 TL100, TL100A, TL70, TL70 A, TL80, TL80A, TL90, TL90A TM110-TM190, TS120, TS80, TL80 A -TL100 A</td> </tr> <tr> <th>Force (N)</th> <th>Length (mm)</th> <th>Ram (mm)</th> <th>OE Ref</th> </tr> <tr> <td>220</td> <td>585</td> <td>255</td> <td>81865239</td> </tr> </tbody> </table>	Application	Models	Rear window	4635, 4835, 5635, 6635, 7635 5640, 6640, 7740, 7840, 8240, 8340 8160, 8260, 8360, 8560 L60, L65, L75, L85, L95 M100, M115, M135, M160 TL100, TL100A, TL70, TL70 A, TL80, TL80A, TL90, TL90A TM110-TM190, TS120, TS80, TL80 A -TL100 A	Force (N)	Length (mm)	Ram (mm)	OE Ref	220	585	255	81865239	 <p>M8</p>  <p>M8</p>
Application	Models													
Rear window	4635, 4835, 5635, 6635, 7635 5640, 6640, 7740, 7840, 8240, 8340 8160, 8260, 8360, 8560 L60, L65, L75, L85, L95 M100, M115, M135, M160 TL100, TL100A, TL70, TL70 A, TL80, TL80A, TL90, TL90A TM110-TM190, TS120, TS80, TL80 A -TL100 A													
Force (N)	Length (mm)	Ram (mm)	OE Ref											
220	585	255	81865239											
 <p>780168</p>	<table border="1"> <thead> <tr> <th>Application</th> <th>Models</th> </tr> </thead> <tbody> <tr> <td>Rear Window</td> <td>Ares 540, 546, 550, 556, 566, 610, 616, 620, 626, 630, 636, 696, 710, Ares 715, 720, 725, 735, 816, 826, Atlas 915, 925, 926, 935, 936</td> </tr> <tr> <th>Force (N)</th> <th>Length (mm)</th> <th>Ram (mm)</th> <th>OE Ref</th> </tr> <tr> <td>175</td> <td>565</td> <td>240</td> <td>7700044591</td> </tr> </tbody> </table>	Application	Models	Rear Window	Ares 540, 546, 550, 556, 566, 610, 616, 620, 626, 630, 636, 696, 710, Ares 715, 720, 725, 735, 816, 826, Atlas 915, 925, 926, 935, 936	Force (N)	Length (mm)	Ram (mm)	OE Ref	175	565	240	7700044591	 <p>10mm</p>  <p>10mm</p>
Application	Models													
Rear Window	Ares 540, 546, 550, 556, 566, 610, 616, 620, 626, 630, 636, 696, 710, Ares 715, 720, 725, 735, 816, 826, Atlas 915, 925, 926, 935, 936													
Force (N)	Length (mm)	Ram (mm)	OE Ref											
175	565	240	7700044591											
 <p>53184</p>	<table border="1"> <thead> <tr> <th>Application</th> <th>Models</th> </tr> </thead> <tbody> <tr> <td>Rear window</td> <td>3230 4210, 4220, 4230, 4240 844 955, 1055, 1255, 1455 856, 956, 1056 485, 685, 785, 885</td> </tr> <tr> <th>Force (N)</th> <th>Length (mm)</th> <th>Ram (mm)</th> <th>OE Ref</th> </tr> <tr> <td>180</td> <td>550</td> <td>235</td> <td>3234163R1</td> </tr> </tbody> </table>	Application	Models	Rear window	3230 4210, 4220, 4230, 4240 844 955, 1055, 1255, 1455 856, 956, 1056 485, 685, 785, 885	Force (N)	Length (mm)	Ram (mm)	OE Ref	180	550	235	3234163R1	 <p>10mm</p>  <p>10mm</p>
Application	Models													
Rear window	3230 4210, 4220, 4230, 4240 844 955, 1055, 1255, 1455 856, 956, 1056 485, 685, 785, 885													
Force (N)	Length (mm)	Ram (mm)	OE Ref											
180	550	235	3234163R1											

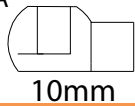
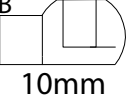
Gas Struts

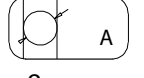
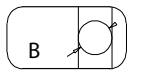
Note:

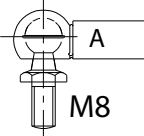
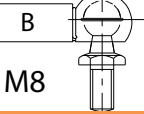
Check Newton Rating Of Existing Gas Strut Before Ordering A Replacement. Using A Gas Strut With A Lower Or Higher Newton Rating Can Result In Damage Or Glass Breakage.

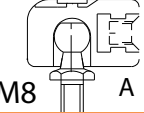
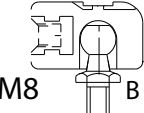
59069 	Application Models Bonnet 6020 Series 6030 Series 6025 Series	A  B 
	Force (N) Length (mm) Ram (mm) OE Ref 510 550 205 AL174088	
59078 	Application Models Bonnet 6020 Series 6030 Series 7030 Series	A  B 
	Force (N) Length (mm) Ram (mm) OE Ref 800 545 190 AL174087	
59079 	Application Models Sun roof 6000 Series 6010 Series 6020 Series 6030 Series 7030 Series	A  10mm B  10mm
	Force (N) Length (mm) Ram (mm) OE Ref 200 515 220 AL160699	
3935E 	Application Models Rear window 550, 560, 565, 575, 590, 595	A  8mm B  8mm
	Force (N) Length (mm) Ram (mm) OE Ref 350 505 210	
2836 	Application Models Door 2910, 3610, 3910, 4110, 4610, 5610, 6610, 7610 3430, 3930, 4630, 4830, 5030	A  M8 B  M8
	Force (N) Length (mm) Ram (mm) OE Ref 220 505 205 83944272	
2834 	Application Models Rear window 2610, 2910, 3610, 3910, 4110, 4610, 5110, 5610, 6410, 6610, 7410, 7610, 7710 3230, 3430, 3930, 4630, 4830, 5030	A  M8 B  M8
	Force (N) Length (mm) Ram (mm) OE Ref 200 500 210 83932024	

Gas Struts



Note:

Check Newton Rating Of Existing Gas Strut Before Ordering A Replacement. Using A Gas Strut With A Lower Or Higher Newton Rating Can Result In Damage Or Glass Breakage.

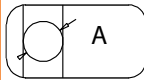
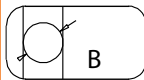

	<table border="1"> <thead> <tr> <th>Application</th> <th>Models</th> </tr> </thead> <tbody> <tr> <td>Rear window</td> <td>550, 560, 565, 575, 590, 595</td> </tr> </tbody> </table>	Application	Models	Rear window	550, 560, 565, 575, 590, 595				
	Application	Models							
Rear window	550, 560, 565, 575, 590, 595								
<table border="1"> <thead> <tr> <th>Force (N)</th> <th>Length (mm)</th> <th>Ram (mm)</th> <th>OE Ref</th> </tr> </thead> <tbody> <tr> <td>350</td> <td>500</td> <td>210</td> <td></td> </tr> </tbody> </table>	Force (N)	Length (mm)	Ram (mm)	OE Ref	350	500	210		
Force (N)	Length (mm)	Ram (mm)	OE Ref						
350	500	210							
	<table border="1"> <thead> <tr> <th>Application</th> <th>Models</th> </tr> </thead> <tbody> <tr> <td>Rear window</td> <td>6000 Series 6010 Series 6020 Series 6030 Series</td> </tr> </tbody> </table>	Application	Models	Rear window	6000 Series 6010 Series 6020 Series 6030 Series				
	Application	Models							
Rear window	6000 Series 6010 Series 6020 Series 6030 Series								
<table border="1"> <thead> <tr> <th>Force (N)</th> <th>Length (mm)</th> <th>Ram (mm)</th> <th>OE Ref</th> </tr> </thead> <tbody> <tr> <td>130</td> <td>500</td> <td>195</td> <td>AL114803</td> </tr> </tbody> </table>	Force (N)	Length (mm)	Ram (mm)	OE Ref	130	500	195	AL114803	
Force (N)	Length (mm)	Ram (mm)	OE Ref						
130	500	195	AL114803						
	<table border="1"> <thead> <tr> <th>Application</th> <th>Models</th> </tr> </thead> <tbody> <tr> <td>Rear window</td> <td>342, 350, 352, 355, 360, 362, 365, 372, 375, 382, 390, 396, 398, 399</td> </tr> </tbody> </table>	Application	Models	Rear window	342, 350, 352, 355, 360, 362, 365, 372, 375, 382, 390, 396, 398, 399				
	Application	Models							
Rear window	342, 350, 352, 355, 360, 362, 365, 372, 375, 382, 390, 396, 398, 399								
<table border="1"> <thead> <tr> <th>Force (N)</th> <th>Length (mm)</th> <th>Ram (mm)</th> <th>OE Ref</th> </tr> </thead> <tbody> <tr> <td>200</td> <td>500</td> <td>205</td> <td>3476187M1</td> </tr> </tbody> </table>	Force (N)	Length (mm)	Ram (mm)	OE Ref	200	500	205	3476187M1	
Force (N)	Length (mm)	Ram (mm)	OE Ref						
200	500	205	3476187M1						
	<table border="1"> <thead> <tr> <th>Application</th> <th>Models</th> </tr> </thead> <tbody> <tr> <td>Rear window</td> <td>240, 250, 265, 275, 290 2620, 2640, 2645, 2680, 2685, 2720, 2725 550, 565, 575, 590, 595</td> </tr> </tbody> </table>	Application	Models	Rear window	240, 250, 265, 275, 290 2620, 2640, 2645, 2680, 2685, 2720, 2725 550, 565, 575, 590, 595				
	Application	Models							
Rear window	240, 250, 265, 275, 290 2620, 2640, 2645, 2680, 2685, 2720, 2725 550, 565, 575, 590, 595								
<table border="1"> <thead> <tr> <th>Force (N)</th> <th>Length (mm)</th> <th>Ram (mm)</th> <th>OE Ref</th> </tr> </thead> <tbody> <tr> <td>250</td> <td>500</td> <td>210</td> <td>1873903M1</td> </tr> </tbody> </table>	Force (N)	Length (mm)	Ram (mm)	OE Ref	250	500	210	1873903M1	
Force (N)	Length (mm)	Ram (mm)	OE Ref						
250	500	210	1873903M1						
	<table border="1"> <thead> <tr> <th>Application</th> <th>Models</th> </tr> </thead> <tbody> <tr> <td>Rear window</td> <td>90 Series - 100-90</td> </tr> </tbody> </table>	Application	Models	Rear window	90 Series - 100-90				
	Application	Models							
Rear window	90 Series - 100-90								
<table border="1"> <thead> <tr> <th>Force (N)</th> <th>Length (mm)</th> <th>Ram (mm)</th> <th>OE Ref</th> </tr> </thead> <tbody> <tr> <td>250</td> <td>500</td> <td>200</td> <td></td> </tr> </tbody> </table>	Force (N)	Length (mm)	Ram (mm)	OE Ref	250	500	200		
Force (N)	Length (mm)	Ram (mm)	OE Ref						
250	500	200							
	<table border="1"> <thead> <tr> <th>Application</th> <th>Models</th> </tr> </thead> <tbody> <tr> <td>Rear window</td> <td>100-90, 110-90, 115-90, 55-90, 60-90, 65-90, 70-90, 80-90, 85-90, 90-90 60-94, 65-94, 72-94, 82-94, 88-94</td> </tr> </tbody> </table>	Application	Models	Rear window	100-90, 110-90, 115-90, 55-90, 60-90, 65-90, 70-90, 80-90, 85-90, 90-90 60-94, 65-94, 72-94, 82-94, 88-94				
	Application	Models							
Rear window	100-90, 110-90, 115-90, 55-90, 60-90, 65-90, 70-90, 80-90, 85-90, 90-90 60-94, 65-94, 72-94, 82-94, 88-94								
<table border="1"> <thead> <tr> <th>Force (N)</th> <th>Length (mm)</th> <th>Ram (mm)</th> <th>OE Ref</th> </tr> </thead> <tbody> <tr> <td>130</td> <td>500</td> <td>200</td> <td>5113767</td> </tr> </tbody> </table>	Force (N)	Length (mm)	Ram (mm)	OE Ref	130	500	200	5113767	
Force (N)	Length (mm)	Ram (mm)	OE Ref						
130	500	200	5113767						

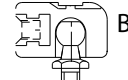

Gas Struts **Note:** Check newton rating of existing gas strut before ordering a replacement. Using a gas strut with a lower or higher newton rating can result in damage or glass breakage

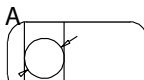
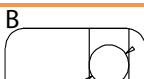
 <p>780162</p>	Application	Models	 <p>8mm</p>	
	Rear Window		891, 891-4, 891-4S, 891S, 751-4S, 751S 951, 951-4, 981-4S, 981S, 981, 981-4 681, 681-4, 681-4S, 681S	 <p>8mm</p>
	Force (N)	Length (mm)	Ram (mm)	OE Ref
	150	500	215	7701025587

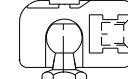
 <p>59818</p>	Application	Models	 <p>M8</p>	
	Rear window		40 Series	 <p>M8</p>
	Force (N)	Length (mm)	Ram (mm)	OE Ref
	200	495	205	AL33170

 <p>780161</p>	Application	Models	 <p>8mm</p>	
	Rear window		Renault 100 461 5515 651 651-4 681 681-4 681-4S 681S 751S 781-4S 752 785	 <p>8mm</p>
	Force (N)	Length (mm)	Ram (mm)	OE Ref
	400	495	206	7701350668

 <p>6716</p>	Application	Models	 <p>M8</p>	
	Door		4215, 4220, 4225, 4235, 4240, 4245, 4255, 4260, 4265, 4270, 4315, 4320, 4325, 4335, 4345, 4355, 4360, 4365, 4370	 <p>M8</p>
	Force (N)	Length (mm)	Ram (mm)	OE Ref
	150	490	200	3804759M1

 <p>52092</p>	Application	Models	 <p>M8</p>	
	Rear window		CX100, CX50, CX60, CX70, CX80, CX90 MX100, MX100 C, MX110, MX120, MX135, MX150, MX170, MX180, MX200, MX220, MX240, MX80 C, MX90 C	 <p>M8</p>
	Force (N)	Length (mm)	Ram (mm)	OE Ref
	200	485	205	189447A2



3943
8-18 Steel Eye for Gas Struts - All Gas Strut



3942
Ball Joint 8-18 Steel - All Gas Strut





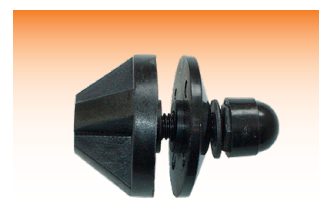





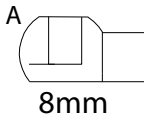
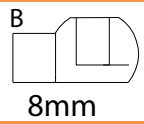

6491
Roof Hatch Gas Strut Clip
390 390T 398 398T

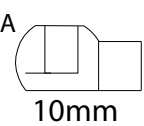
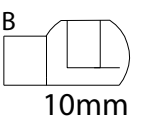

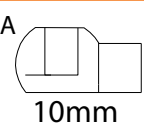
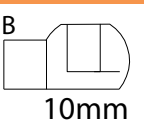
41075
Gas Strut Bracket Ford Case
John Deere Case 484 584 684
784 884 John Deere 1030 1040
1130 1140 1630 940

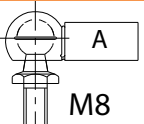
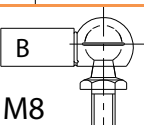
Gas Struts

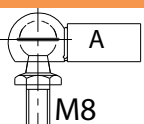
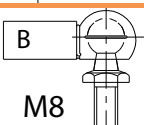
Note: Check newton rating of existing gas strut before ordering a replacement. Using a gas strut with a lower or higher newton rating can result in damage or glass breakage

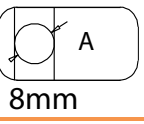
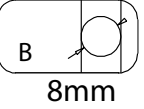
6353 	Application	Models	 8mm	
	Rear window		 8mm	
	Force (N)	Length (mm)	Ram (mm)	OE Ref
	200	485	205	3548042M91
780165 	Application	Models	 10mm	
	Door	Renault 12-14 55-12 55-14 70-12 70-14 80-14	 10mm	
	Force (N)	Length (mm)	Ram (mm)	OE Ref
	200	485	205	6005012549
43533 	Application	Models	 10mm	
	Rear window	T6040 T6050 T6060 T6070 T6080 T7030 T7040 T7050 T7060 TS1100A TS1110A TS115A TS125A	 10mm	
	Force (N)	Length (mm)	Ram (mm)	OE Ref
	200	490	245	82022486
3621 	Application	Models	 M8	
	Rear window		 M8	
	Force (N)	Length (mm)	Ram (mm)	OE Ref
	350	415	170	
59675 	Application	Models	 M8	
	Door	UR3 Series 7520, 7540, 8520, 8540, 9520, 9540, 10520, 10540	 M8	
	Force (N)	Length (mm)	Ram (mm)	OE Ref
	200	410	165	10368919
3659 	Application	Models	 8mm	
	Rear window	UR1 Series - 5211, 5245, 6211, 6245, 7211, 7245, 7711, 7745	 8mm	
	Force (N)	Length (mm)	Ram (mm)	OE Ref
	180	410	155	8Z2155218Z2018L

Gas Struts **Note:** Check newton rating of existing gas strut before ordering a replacement. Using a gas strut with a lower or higher newton rating can result in damage or glass breakage.

 <p>780172</p>	<table border="1"> <thead> <tr> <th>Application</th> <th>Models</th> </tr> </thead> <tbody> <tr> <td>Door</td> <td>55-12 F, 55-12 LB, 55-12 V, 55-14 V, 70-12 F, 70-12 LB, 70-12 V, 70-14 F, 70-14 LB, 80-12 F, 80-12 V, 80-14 F, 80-14 LB, 80-14 V, Dionis 110, 120, 130, 140, Fructus 110, 120, 130, 140, Pales 210, 220, 230, 240</td> </tr> <tr> <th>Force (N)</th> <th>Length (mm)</th> <th>Ram (mm)</th> <th>OE Ref</th> </tr> <tr> <td>200</td> <td>410</td> <td>160</td> <td>6005012542</td> </tr> </tbody> </table>	Application	Models	Door	55-12 F, 55-12 LB, 55-12 V, 55-14 V, 70-12 F, 70-12 LB, 70-12 V, 70-14 F, 70-14 LB, 80-12 F, 80-12 V, 80-14 F, 80-14 LB, 80-14 V, Dionis 110, 120, 130, 140, Fructus 110, 120, 130, 140, Pales 210, 220, 230, 240	Force (N)	Length (mm)	Ram (mm)	OE Ref	200	410	160	6005012542	 <p>10mm</p>  <p>10mm</p>
Application	Models													
Door	55-12 F, 55-12 LB, 55-12 V, 55-14 V, 70-12 F, 70-12 LB, 70-12 V, 70-14 F, 70-14 LB, 80-12 F, 80-12 V, 80-14 F, 80-14 LB, 80-14 V, Dionis 110, 120, 130, 140, Fructus 110, 120, 130, 140, Pales 210, 220, 230, 240													
Force (N)	Length (mm)	Ram (mm)	OE Ref											
200	410	160	6005012542											
 <p>59681</p>	<table border="1"> <thead> <tr> <th>Application</th> <th>Models</th> </tr> </thead> <tbody> <tr> <td>Back Window</td> <td>UR1 Series 5211, 5245, 6211, 6245, 7211, 7245, 7711, 7745</td> </tr> <tr> <th>Force (N)</th> <th>Length (mm)</th> <th>Ram (mm)</th> <th>OE Ref</th> </tr> <tr> <td>200</td> <td>400</td> <td>151</td> <td>60117921</td> </tr> </tbody> </table>	Application	Models	Back Window	UR1 Series 5211, 5245, 6211, 6245, 7211, 7245, 7711, 7745	Force (N)	Length (mm)	Ram (mm)	OE Ref	200	400	151	60117921	 <p>10mm</p>  <p>10mm</p>
Application	Models													
Back Window	UR1 Series 5211, 5245, 6211, 6245, 7211, 7245, 7711, 7745													
Force (N)	Length (mm)	Ram (mm)	OE Ref											
200	400	151	60117921											
 <p>1481</p>	<table border="1"> <thead> <tr> <th>Application</th> <th>Models</th> </tr> </thead> <tbody> <tr> <td>Rear window</td> <td>C & G Cabs</td> </tr> <tr> <th>Force (N)</th> <th>Length (mm)</th> <th>Ram (mm)</th> <th>OE Ref</th> </tr> <tr> <td>140</td> <td>395</td> <td>150</td> <td></td> </tr> </tbody> </table>	Application	Models	Rear window	C & G Cabs	Force (N)	Length (mm)	Ram (mm)	OE Ref	140	395	150		 <p>M8</p>  <p>M8</p>
Application	Models													
Rear window	C & G Cabs													
Force (N)	Length (mm)	Ram (mm)	OE Ref											
140	395	150												
 <p>780166</p>	<table border="1"> <thead> <tr> <th>Application</th> <th>Models</th> </tr> </thead> <tbody> <tr> <td>Rear window</td> <td>Renault 12-14 61-12 61-14 75-14 Renault 12-14 61-12 61-14 75-14 95-14 103-12 103-14 70-12 70-14 80-12 80-14 110-14</td> </tr> <tr> <th>Force (N)</th> <th>Length (mm)</th> <th>Ram (mm)</th> <th>OE Ref</th> </tr> <tr> <td>180</td> <td>390</td> <td>155</td> <td>7700005276</td> </tr> </tbody> </table>	Application	Models	Rear window	Renault 12-14 61-12 61-14 75-14 Renault 12-14 61-12 61-14 75-14 95-14 103-12 103-14 70-12 70-14 80-12 80-14 110-14	Force (N)	Length (mm)	Ram (mm)	OE Ref	180	390	155	7700005276	 <p>8mm</p>  <p>8mm</p>
Application	Models													
Rear window	Renault 12-14 61-12 61-14 75-14 Renault 12-14 61-12 61-14 75-14 95-14 103-12 103-14 70-12 70-14 80-12 80-14 110-14													
Force (N)	Length (mm)	Ram (mm)	OE Ref											
180	390	155	7700005276											
 <p>2107</p>	<table border="1"> <thead> <tr> <th>Application</th> <th>Models</th> </tr> </thead> <tbody> <tr> <td>Rear window</td> <td>2610, 3610, 4110, 4610, 5610, 6410, 6610, 6710, 6810, 7410, 7610, 7710, 7810, 7910, 8210 8530, 8630, 8730, 8830 TW5- TW35 5900</td> </tr> <tr> <th>Force (N)</th> <th>Length (mm)</th> <th>Ram (mm)</th> <th>OE Ref</th> </tr> <tr> <td>160</td> <td>375</td> <td>150</td> <td>83952213</td> </tr> </tbody> </table>	Application	Models	Rear window	2610, 3610, 4110, 4610, 5610, 6410, 6610, 6710, 6810, 7410, 7610, 7710, 7810, 7910, 8210 8530, 8630, 8730, 8830 TW5- TW35 5900	Force (N)	Length (mm)	Ram (mm)	OE Ref	160	375	150	83952213	 <p>M8</p>  <p>M8</p>
Application	Models													
Rear window	2610, 3610, 4110, 4610, 5610, 6410, 6610, 6710, 6810, 7410, 7610, 7710, 7810, 7910, 8210 8530, 8630, 8730, 8830 TW5- TW35 5900													
Force (N)	Length (mm)	Ram (mm)	OE Ref											
160	375	150	83952213											
 <p>780170</p>	<table border="1"> <thead> <tr> <th>Application</th> <th>Models</th> </tr> </thead> <tbody> <tr> <td>Rear Window</td> <td>Cergos Series Cergos 330, Cergos 335, Cergos 340, Cergos 345, Cergos 350, Cergos 355</td> </tr> <tr> <th>Force (N)</th> <th>Length (mm)</th> <th>Ram (mm)</th> <th>OE Ref</th> </tr> <tr> <td>300</td> <td>370</td> <td>145</td> <td>6005022224</td> </tr> </tbody> </table>	Application	Models	Rear Window	Cergos Series Cergos 330, Cergos 335, Cergos 340, Cergos 345, Cergos 350, Cergos 355	Force (N)	Length (mm)	Ram (mm)	OE Ref	300	370	145	6005022224	 <p>10mm</p>  <p>10mm</p>
Application	Models													
Rear Window	Cergos Series Cergos 330, Cergos 335, Cergos 340, Cergos 345, Cergos 350, Cergos 355													
Force (N)	Length (mm)	Ram (mm)	OE Ref											
300	370	145	6005022224											
 <p>59770</p>	<table border="1"> <thead> <tr> <th>Application</th> <th>Models</th> </tr> </thead> <tbody> <tr> <td>Bonnet</td> <td>6000 Series 6010 SE Series 6010 Series</td> </tr> <tr> <th>Force (N)</th> <th>Length (mm)</th> <th>Ram (mm)</th> <th>OE Ref</th> </tr> <tr> <td>900</td> <td>355</td> <td>105</td> <td>AL77767</td> </tr> </tbody> </table>	Application	Models	Bonnet	6000 Series 6010 SE Series 6010 Series	Force (N)	Length (mm)	Ram (mm)	OE Ref	900	355	105	AL77767	 <p>10mm</p>  <p>8.1mm</p>
Application	Models													
Bonnet	6000 Series 6010 SE Series 6010 Series													
Force (N)	Length (mm)	Ram (mm)	OE Ref											
900	355	105	AL77767											

Gas Struts **Note:** Check newton rating of existing gas strut before ordering a replacement. Using a gas strut with a lower or higher newton rating can result in damage or glass breakage.

 <p>3658</p>	<table border="1"> <thead> <tr> <th>Application</th> <th>Models</th> </tr> </thead> <tbody> <tr> <td>Rear window</td> <td>UR1 Series, UR2 Series</td> </tr> <tr> <th>Force (N)</th> <th>Length (mm)</th> <th>Ram (mm)</th> <th>OE Ref</th> </tr> <tr> <td>175</td> <td>325</td> <td>110</td> <td>981468 175N EE</td> </tr> </tbody> </table>	Application	Models	Rear window	UR1 Series, UR2 Series	Force (N)	Length (mm)	Ram (mm)	OE Ref	175	325	110	981468 175N EE	 <p>A 8mm</p>  <p>B 8mm</p>
Application	Models													
Rear window	UR1 Series, UR2 Series													
Force (N)	Length (mm)	Ram (mm)	OE Ref											
175	325	110	981468 175N EE											
 <p>780164</p>	<table border="1"> <thead> <tr> <th>Application</th> <th>Models</th> </tr> </thead> <tbody> <tr> <td>Sun roof</td> <td>Renault 12-14 55-12 55-14 70-12 70-14 80-14</td> </tr> <tr> <th>Force (N)</th> <th>Length (mm)</th> <th>Ram (mm)</th> <th>OE Ref</th> </tr> <tr> <td>200</td> <td>325</td> <td>125</td> <td>6005014318</td> </tr> </tbody> </table>	Application	Models	Sun roof	Renault 12-14 55-12 55-14 70-12 70-14 80-14	Force (N)	Length (mm)	Ram (mm)	OE Ref	200	325	125	6005014318	 <p>A 10mm</p>  <p>B 10mm</p>
Application	Models													
Sun roof	Renault 12-14 55-12 55-14 70-12 70-14 80-14													
Force (N)	Length (mm)	Ram (mm)	OE Ref											
200	325	125	6005014318											
 <p>1332</p>	<table border="1"> <thead> <tr> <th>Application</th> <th>Models</th> </tr> </thead> <tbody> <tr> <td>Rear window</td> <td>135</td> </tr> <tr> <th>Force (N)</th> <th>Length (mm)</th> <th>Ram (mm)</th> <th>OE Ref</th> </tr> <tr> <td>250</td> <td>290</td> <td>90</td> <td></td> </tr> </tbody> </table>	Application	Models	Rear window	135	Force (N)	Length (mm)	Ram (mm)	OE Ref	250	290	90		 <p>A M8</p>  <p>B M8</p>
Application	Models													
Rear window	135													
Force (N)	Length (mm)	Ram (mm)	OE Ref											
250	290	90												
 <p>3672</p>	<table border="1"> <thead> <tr> <th>Application</th> <th>Models</th> </tr> </thead> <tbody> <tr> <td>Rear window</td> <td>Duncan Cab - New Type</td> </tr> <tr> <th>Force (N)</th> <th>Length (mm)</th> <th>Ram (mm)</th> <th>OE Ref</th> </tr> <tr> <td>350</td> <td>285</td> <td>95</td> <td></td> </tr> </tbody> </table>	Application	Models	Rear window	Duncan Cab - New Type	Force (N)	Length (mm)	Ram (mm)	OE Ref	350	285	95		 <p>A 8mm</p>  <p>B 8mm</p>
Application	Models													
Rear window	Duncan Cab - New Type													
Force (N)	Length (mm)	Ram (mm)	OE Ref											
350	285	95												
 <p>3933</p>	<table border="1"> <thead> <tr> <th>Application</th> <th>Models</th> </tr> </thead> <tbody> <tr> <td>Rear window</td> <td>Leyland</td> </tr> <tr> <th>Force (N)</th> <th>Length (mm)</th> <th>Ram (mm)</th> <th>OE Ref</th> </tr> <tr> <td>300</td> <td>280</td> <td>90</td> <td></td> </tr> </tbody> </table>	Application	Models	Rear window	Leyland	Force (N)	Length (mm)	Ram (mm)	OE Ref	300	280	90		 <p>A 8mm</p>  <p>B 8mm</p>
Application	Models													
Rear window	Leyland													
Force (N)	Length (mm)	Ram (mm)	OE Ref											
300	280	90												
 <p>6389</p>	<table border="1"> <thead> <tr> <th>Application</th> <th>Models</th> </tr> </thead> <tbody> <tr> <td>Door</td> <td>240, 250, 265, 275, 290 350, 355, 360, 362, 365, 375, 390, 390 T, 398, 399</td> </tr> <tr> <th>Force (N)</th> <th>Length (mm)</th> <th>Ram (mm)</th> <th>OE Ref</th> </tr> <tr> <td>290</td> <td>275</td> <td>85</td> <td>3478319M1</td> </tr> </tbody> </table>	Application	Models	Door	240, 250, 265, 275, 290 350, 355, 360, 362, 365, 375, 390, 390 T, 398, 399	Force (N)	Length (mm)	Ram (mm)	OE Ref	290	275	85	3478319M1	 <p>A M8</p>  <p>B M8</p>
Application	Models													
Door	240, 250, 265, 275, 290 350, 355, 360, 362, 365, 375, 390, 390 T, 398, 399													
Force (N)	Length (mm)	Ram (mm)	OE Ref											
290	275	85	3478319M1											
 <p>59663</p>	<table border="1"> <thead> <tr> <th>Application</th> <th>Models</th> </tr> </thead> <tbody> <tr> <td>Door</td> <td>6000 Series 6010 Series</td> </tr> <tr> <th>Force (N)</th> <th>Length (mm)</th> <th>Ram (mm)</th> <th>OE Ref</th> </tr> <tr> <td>250</td> <td>260</td> <td>90</td> <td>AL110629</td> </tr> </tbody> </table>	Application	Models	Door	6000 Series 6010 Series	Force (N)	Length (mm)	Ram (mm)	OE Ref	250	260	90	AL110629	 <p>A M8</p>  <p>B M8</p>
Application	Models													
Door	6000 Series 6010 Series													
Force (N)	Length (mm)	Ram (mm)	OE Ref											
250	260	90	AL110629											

Gas Struts **Note:** Check newton rating of existing gas strut before ordering a replacement. Using a gas strut with a lower or higher newton rating can result in damage or glass breakage.

2835 	Application	Models		
	Front window	2910, 3610, 3910, 4110, 4610, 5610, 6610, 7610		
	Force (N)	Length (mm)	Ram (mm)	OE Ref
	100	255	90	83944280
780171 	Application	Models		
	Door	Cergos 330, Cergos 335, Cergos 340, Cergos 345, Cergos 350, Cergos 355 Ergos 105, Ergos 446 Hydro, Ergos 456 Hydro, Ergos 466 Hydro, Ergos 85, Ergos 95		
	Force (N)	Length (mm)	Ram (mm)	OE Ref
	200	255	95	6005014361
52091 	Application	Models		
	Door	CX100, CX50, CX60, CX70, CX80, CX90 5120, 5130, 5140, 5150 MX100, MX100 C, MX110, MX120, MX135, MX150, MX170, MX80 C, MX90 C		
	Force (N)	Length (mm)	Ram (mm)	OE Ref
	350	250	77	1977416C1
59664 	Application	Models		
	Door	5020 Series 6030 Series 7030 Series 6030 Premium Series 5025 Series 7030 Premium Series		
	Force (N)	Length (mm)	Ram (mm)	OE Ref
	350	245	70	AL174358
42772 	Application	Models		
	Steering column	T6010, T6020, T6030, T6040, T6050, T6060, T6070, T6080, T6090 T7030, T7040, T7050, T7060, T7070 TS100 A, TS110 A, TS115 A, TS125 A, TS130 A, TS135 A		
	Force (N)	Length (mm)	Ram (mm)	OE Ref
	350	235	70	82036016
59952 	Application	Models		
	Steering column	5020 Series 6000 Series 6010 Series 6020 SE Series 6020 Series 6030 Series 5R Series		
	Force (N)	Length (mm)	Ram (mm)	OE Ref
	330	230	65	AL150755
61950 	Application	Models		
	Door	5425, 5435, 5445, 5455, 5460, 5465, 5470, 5480 6110-6190 6235-6290 6445-6499 7465-7495 8110-8180 8210-8280		
	Force (N)	Length (mm)	Ram (mm)	OE Ref
	600	230	70	3902121M3

Gas Struts **Note:** Check newton rating of existing gas strut before ordering a replacement. Using a gas strut with a lower or higher newton rating can result in damage or glass breakage.

<p>2699</p> 	<table border="1"> <thead> <tr> <th>Application</th> <th>Models</th> </tr> </thead> <tbody> <tr> <td>Sun roof</td> <td>2610-8210 8530-8830 5640-8340 8160-8560 M100-M160 TM110-TM180 TS90-TS115 TW5- TW35 5900</td> </tr> <tr> <th>Force (N)</th> <th>Length (mm)</th> <th>Ram (mm)</th> <th>OE Ref</th> </tr> <tr> <td>220</td> <td>220</td> <td>65</td> <td>83949895</td> </tr> </tbody> </table>	Application	Models	Sun roof	2610-8210 8530-8830 5640-8340 8160-8560 M100-M160 TM110-TM180 TS90-TS115 TW5- TW35 5900	Force (N)	Length (mm)	Ram (mm)	OE Ref	220	220	65	83949895	 <p>8mm</p>  <p>8mm</p>
Application	Models													
Sun roof	2610-8210 8530-8830 5640-8340 8160-8560 M100-M160 TM110-TM180 TS90-TS115 TW5- TW35 5900													
Force (N)	Length (mm)	Ram (mm)	OE Ref											
220	220	65	83949895											
<p>52215</p> 	<table border="1"> <thead> <tr> <th>Application</th> <th>Models</th> </tr> </thead> <tbody> <tr> <td>Sun roof</td> <td>1190, 1290, 1390, 1490, 1690 1194, 1294, 1394, 1494, 1594, 1694</td> </tr> <tr> <th>Force (N)</th> <th>Length (mm)</th> <th>Ram (mm)</th> <th>OE Ref</th> </tr> <tr> <td>330</td> <td>220</td> <td>67</td> <td>3901826M91</td> </tr> </tbody> </table>	Application	Models	Sun roof	1190, 1290, 1390, 1490, 1690 1194, 1294, 1394, 1494, 1594, 1694	Force (N)	Length (mm)	Ram (mm)	OE Ref	330	220	67	3901826M91	 <p>8mm</p>  <p>8mm</p>
Application	Models													
Sun roof	1190, 1290, 1390, 1490, 1690 1194, 1294, 1394, 1494, 1594, 1694													
Force (N)	Length (mm)	Ram (mm)	OE Ref											
330	220	67	3901826M91											
<p>41767</p> 	<table border="1"> <thead> <tr> <th>Application</th> <th>Models</th> </tr> </thead> <tbody> <tr> <td>Door</td> <td>5640, 6640, 7740, 7840, 8240, 8340 8160, 8260, 8360, 8560 TM110, TM115, TM120, TM125, TM130, TM135, TM140, TM150, TM155, TM165, TM175, TM180, TM190 TS100, TS110, TS115, TS80, TS90</td> </tr> <tr> <th>Force (N)</th> <th>Length (mm)</th> <th>Ram (mm)</th> <th>OE Ref</th> </tr> <tr> <td>310</td> <td>215</td> <td>57</td> <td>87378324</td> </tr> </tbody> </table>	Application	Models	Door	5640, 6640, 7740, 7840, 8240, 8340 8160, 8260, 8360, 8560 TM110, TM115, TM120, TM125, TM130, TM135, TM140, TM150, TM155, TM165, TM175, TM180, TM190 TS100, TS110, TS115, TS80, TS90	Force (N)	Length (mm)	Ram (mm)	OE Ref	310	215	57	87378324	 <p>M8</p>  <p>M8</p>
Application	Models													
Door	5640, 6640, 7740, 7840, 8240, 8340 8160, 8260, 8360, 8560 TM110, TM115, TM120, TM125, TM130, TM135, TM140, TM150, TM155, TM165, TM175, TM180, TM190 TS100, TS110, TS115, TS80, TS90													
Force (N)	Length (mm)	Ram (mm)	OE Ref											
310	215	57	87378324											
<p>43532</p> 	<table border="1"> <thead> <tr> <th>Application</th> <th>Models</th> </tr> </thead> <tbody> <tr> <td>Door</td> <td>T6050 T6060 T6070 T6080 T7030 T7040 T7050 T7060 TS100A TS110A TS115A TS125A TS130A</td> </tr> <tr> <th>Force (N)</th> <th>Length (mm)</th> <th>Ram (mm)</th> <th>OE Ref</th> </tr> <tr> <td>850</td> <td>215</td> <td>115</td> <td>87374182</td> </tr> </tbody> </table>	Application	Models	Door	T6050 T6060 T6070 T6080 T7030 T7040 T7050 T7060 TS100A TS110A TS115A TS125A TS130A	Force (N)	Length (mm)	Ram (mm)	OE Ref	850	215	115	87374182	 <p>10mm</p>  <p>10mm</p>
Application	Models													
Door	T6050 T6060 T6070 T6080 T7030 T7040 T7050 T7060 TS100A TS110A TS115A TS125A TS130A													
Force (N)	Length (mm)	Ram (mm)	OE Ref											
850	215	115	87374182											
<p>4715</p> 	<table border="1"> <thead> <tr> <th>Application</th> <th>Models</th> </tr> </thead> <tbody> <tr> <td>Door/Sun roof</td> <td>2610, 3610, 4110, 4610, 5610, 6410, 6610, 6710, 6810, 7410, 7610, 7710, 7810, 7910, 8210 3230, 3430, 3930, 4630, 8530, 8630, 8730, 8830 TW15, TW25, TW35, TW5 5900</td> </tr> <tr> <th>Force (N)</th> <th>Length (mm)</th> <th>Ram (mm)</th> <th>OE Ref</th> </tr> <tr> <td>300</td> <td>210</td> <td>55</td> <td>83952266</td> </tr> </tbody> </table>	Application	Models	Door/Sun roof	2610, 3610, 4110, 4610, 5610, 6410, 6610, 6710, 6810, 7410, 7610, 7710, 7810, 7910, 8210 3230, 3430, 3930, 4630, 8530, 8630, 8730, 8830 TW15, TW25, TW35, TW5 5900	Force (N)	Length (mm)	Ram (mm)	OE Ref	300	210	55	83952266	 <p>M8</p>  <p>M8</p>
Application	Models													
Door/Sun roof	2610, 3610, 4110, 4610, 5610, 6410, 6610, 6710, 6810, 7410, 7610, 7710, 7810, 7910, 8210 3230, 3430, 3930, 4630, 8530, 8630, 8730, 8830 TW15, TW25, TW35, TW5 5900													
Force (N)	Length (mm)	Ram (mm)	OE Ref											
300	210	55	83952266											
<p>43471</p> 	<table border="1"> <thead> <tr> <th>Application</th> <th>Models</th> </tr> </thead> <tbody> <tr> <td>Door</td> <td>CASE CS CVX</td> </tr> <tr> <th>Force (N)</th> <th>Length (mm)</th> <th>Ram (mm)</th> <th>OE Ref</th> </tr> <tr> <td>500</td> <td>205</td> <td>65</td> <td>134621099</td> </tr> </tbody> </table>	Application	Models	Door	CASE CS CVX	Force (N)	Length (mm)	Ram (mm)	OE Ref	500	205	65	134621099	 <p>10mm</p>  <p>10mm</p>
Application	Models													
Door	CASE CS CVX													
Force (N)	Length (mm)	Ram (mm)	OE Ref											
500	205	65	134621099											
<p>780169</p> 	<table border="1"> <thead> <tr> <th>Application</th> <th>Models</th> </tr> </thead> <tbody> <tr> <td>Door</td> <td>Ares 540 RX, Ares 546 RX, Ares 550 RX, Ares 556 RX, Ares 566 RX, Ares 610 RX, Ares 610 RZ, Ares 616 RX, Ares 620 RZ, Ares 626 RX, Ares 630 RX, Ares 630 RZ, Ares 636 RX, Ares 640 RZ, Ares 696 RX, Ares 710 RZ, Ares 715 RZ, Ares 720 RZ, Ares 725 RZ, Ares 735 RZ, Ares 816 RZ, Ares 826 RZ, Ares 836 RZ</td> </tr> <tr> <th>Force (N)</th> <th>Length (mm)</th> <th>Ram (mm)</th> <th>OE Ref</th> </tr> <tr> <td>200</td> <td>187</td> <td>55</td> <td>7700059809</td> </tr> </tbody> </table>	Application	Models	Door	Ares 540 RX, Ares 546 RX, Ares 550 RX, Ares 556 RX, Ares 566 RX, Ares 610 RX, Ares 610 RZ, Ares 616 RX, Ares 620 RZ, Ares 626 RX, Ares 630 RX, Ares 630 RZ, Ares 636 RX, Ares 640 RZ, Ares 696 RX, Ares 710 RZ, Ares 715 RZ, Ares 720 RZ, Ares 725 RZ, Ares 735 RZ, Ares 816 RZ, Ares 826 RZ, Ares 836 RZ	Force (N)	Length (mm)	Ram (mm)	OE Ref	200	187	55	7700059809	 <p>10mm</p>  <p>10mm</p>
Application	Models													
Door	Ares 540 RX, Ares 546 RX, Ares 550 RX, Ares 556 RX, Ares 566 RX, Ares 610 RX, Ares 610 RZ, Ares 616 RX, Ares 620 RZ, Ares 626 RX, Ares 630 RX, Ares 630 RZ, Ares 636 RX, Ares 640 RZ, Ares 696 RX, Ares 710 RZ, Ares 715 RZ, Ares 720 RZ, Ares 725 RZ, Ares 735 RZ, Ares 816 RZ, Ares 826 RZ, Ares 836 RZ													
Force (N)	Length (mm)	Ram (mm)	OE Ref											
200	187	55	7700059809											

Beacons



51320
Beacon 12V Magnetic
with Bulb Lucas Type



51332
Beacon 12-80v
Mini Xenon



59624
Beacon John Deere
12v Flexi Stem Small



59624R
Beacon John Deere
12v Flexi Stem Small
OE Ref: EPM74596



51321
Beacon 12v Flexi
Stem Lucas Type



53357
Beacon LED Flexi 12/24V



53855
Beacon Flexi 12V



53857
Beacon Kit Includes: Beacon, Bracket,
Wiring, Fuse & Switch

Green Beacons

Part No.

Description

55478

3 Bolt Green Beacon With Seat Belt Kit
Flat Top



55479

Flexi Green Beacon With Seat Belt Kit
Flat Top



55480

3 Bolt Green Beacon With Seat Belt
Domed



55481

Flexi Green Beacon With Seat Belt Kit
Domed



Brackets



51388
Beacon Bracket
Spring Loaded

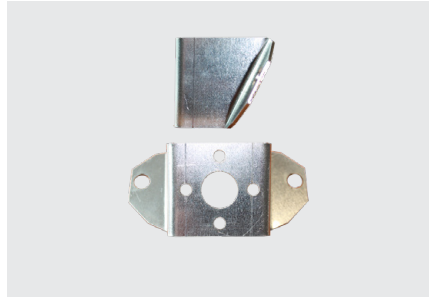

51388B
Bracket Angled for 51388 Beacon
Bracket 42 43 61 62 81 82

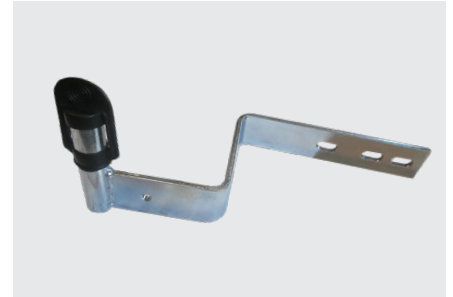

43190
Left Hand Beacon Bracket Assembly Ford
5640 6640 7740 7840 8240 8340

43501
Right Hand Beacon Bracket Assembly Ford
5640 6640 7740 7840 8240 8340



3686
Beacon Bracket



51034
Beacon Bracket Adjustable



3680
Beacon Plug



51422
Beacon Bracket

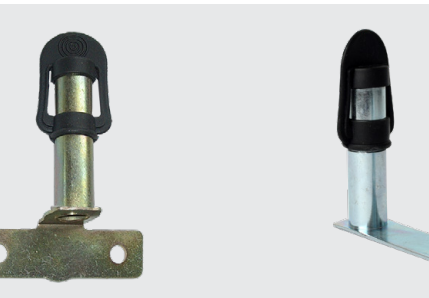

51387
Beacon Bracket



3687
Beacon Bracket



51417
Beacon Bracket
John Deere



51421
Beacon Bracket Adaptor



53858
Beacon Bracket Adaptor - 2 Pin

BEACON RANGE



54838
Beacon 23W Low Profile
Flexi 12/24V
Fitted With 24V Bulb
Bulb to suit is 55318



55553
Lightbar 1 Bolt Fitting
2 Rotators 12V 420mm
IP56 55W Bulbs



54836
Beacon 3 Bolt 12/24V



54835
Beacon 12/24V



54832
Beacon LED 12/24V



54831
Rotating Beacon 23W
Low Profile Pole Mount



54833
Beacon 12/24V 1 Bolt



43628
Beacon 12/24V Pole Mounted
New Holland T6 T7 TM TS
[OE Ref: 82018390](#)
Kit is 43592



43592
Beacon Kit T6.120 - T6.175
T6010 - T6090 T7.170
Includes:
*Beacon, Cable Connections, Bolt Fixing
Set, Beacon Pole, Brackets*
[OE Ref: 710762034](#)

RECHARGEABLE LED WORK LAMPS

54219

- ▶ 5 LED 3W
- ▶ 3 Functions - Full Beam
Half Beam & Flash
- ▶ Multi-Color LED
- ▶ Magnetic Pedestal Base
- ▶ Diecast Aluminium Housing
- ▶ AC & DC Charger Included



54220

- ▶ 16 LED 8W
- ▶ 3 Functions - Full Beam
Half Beam & Flash
- ▶ Multi-Color LED
- ▶ Magnetic Base
- ▶ Diecast Aluminium Housing
- ▶ AC & DC Charger Included



LED WORKLAMPS

53272

16 LED
2500 LUMENS



Watts	25W Flood
Volts	12/24
Body Material	Aluminium
Conformity	IP67
Size mm	W: 109 H: 109 D: 48.5

53274

11 LED
2640 LUMENS



Watts	33W Flood
Volts	12/24
Body Material	Aluminium
Conformity	IP68
Size mm	W: 160 H: 100 D: 70

53273

9 LED
1500 LUMENS



Watts	15W Flood
Volts	12/24
Body Material	Aluminium
Conformity	IP67
Size mm	W: 100 H: 100 D: 40

53275

8 LED
3200 LUMENS



Watts	40W Flood
Volts	12/24
Body Material	Aluminium
Conformity	IP68
Size mm	W: 160 H: 100 D: 70

LED WORKLAMPS

53413

5 LED
700 LUMENS



Watts	8W Flood
Volts	12/24
Body Material	Aluminium
Conformity	
Size mm	W: 100 H: 100 D: 40

53755

4 LED
1000 LUMENS



Watts	9W Flood
Volts	12/24
Body Material	Aluminium
Conformity	
Size mm	W: 90 H: 90

53276 Cab Roof Lamp John Deere 10 Series

4 LED
960 LUMENS



Watts	12W
Volts	12/24
Body Material	Aluminium
Conformity	IP67
Size mm	W: 138 H: 63 D: 45

LED WORKLAMPS

53433

8 LED
1920 LUMENS



Watts	24W Flood
Volts	10 / 30
Body Material	Aluminium
Conformity	IP67
Size mm	W: 140 H: 95 D: 70

53434

6 LED
2400 LUMENS



Watts	24W Flood
Body Material	Aluminium
Size mm	W: 90 H: 150 D: 90

Side Mounted

55416

LED
1200 LUMENS



Work Light Blue Crop Spraying

Work Lamps



2356
Work Lamp Small Rubber Body
55 Watt bulb 125mm Diameter 76mm Deep



2773
Work Lamp 50HX



2324
Work Lamp Cab H3 Single Mounted 6"x3.5"



2324N
Work Lamp Cab H3 Single Mounted 6" x 3.5" **NARROW BACK**



3179
Work Lamp H3 12V Square



4249
Work Lamp Side Mounted Left
Hand Suits Ford Super Q Cab



4250
Work Lamp Side
Mounted Right Hand



51389
Work Lamp John Deere/Case IHC



51400
Work Lamp John Deere Round H3 12V



58296
Work Lamp John Deere
6020 6030 LED 40W 2600 **LUMEN**
[OE Ref:RE233263](#)

Work Lamps



61634
Switch 3000 Front Work Lamp



61635
Switch 4200 - 8200 Front Work Lamp



61644
Switch 4200 - 8200 Rear Work Lamp



7282
Switch Work Lamp Fiat



62750
Work Lamp Oval 54s 64s 74s Also fits JCB



43061
Work Lamp Ford TD55 TD95

54837
**TWIN BULB
WORKLAMP**

1003 - 12V BULB
3678 - 24V BULB

*Available as Spot or Flood
Beam Pattern*

Trailer Lights

Part No.	Description		Lens
1571	Trailer Lamp Round 12v		2586
53098	Trailer Lamp Rubber		53153
53738	<p>Right Hand Rear Light Radex 2800 6 Function Features: 5 pin quick fit connector socket & marker power socket</p> <p>Functions: Stop/Tail/Indicator/ Number Plate/Fog/Reflex Triangle</p> <p>Bulbs included Size 148 x 245 x 60</p>		
53739	Left Hand Rear Light Radex 2800		

4 Pin Plug & Loom

53108

4 Pin Plug & Loom for Trailer Lamp
for Williams



Trailer Lights

Accessories

3764

Trailer Board 4ft with 10mtr Cable

3767

Trailer Board 4ft with 5mtr Cable



3666

Magnetic Lamp Kit + 7.5mtr Cable with bulbs



53411

Magnetic Combi Lamps 2m x 8m LED



54625

Magnetic Lamp Kit & 5mtr Cable



2151

Triangular Reflector Red 153mm (6")



Reflective Conspicuity Tape Clear Rigid Metre

53215 Red

53216 Amber

53217 Clear

53241

Load Resistor



55476

Trailer Reflector Kit 12pcs Red Triangle, Amber Round, Red Round

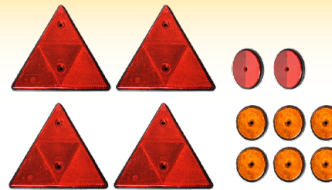

Cables & Core

Part No.	Description	Type	Core	Length	Photo
1355	Suzy Cable with Plastic Plug 2.5mtr	Male/Male	7	2.5 M	
51032	Suzy Cable 5 mtr Male/Male 7 Core	Male/Male	7	5 M	
51033	Suzy Cable 7 Core Male/Female 7 mtr	Male/Female	7	7 M	
2652	Pre Wired Socket & 1.5 Mtr Cable		7	1.5 M	

EASY FIT WIRING SYSTEM



- Fully waterproof
- Quick & easy installation
- No need for specialist tools

Push-and-seal connectors make installation fast and simple!

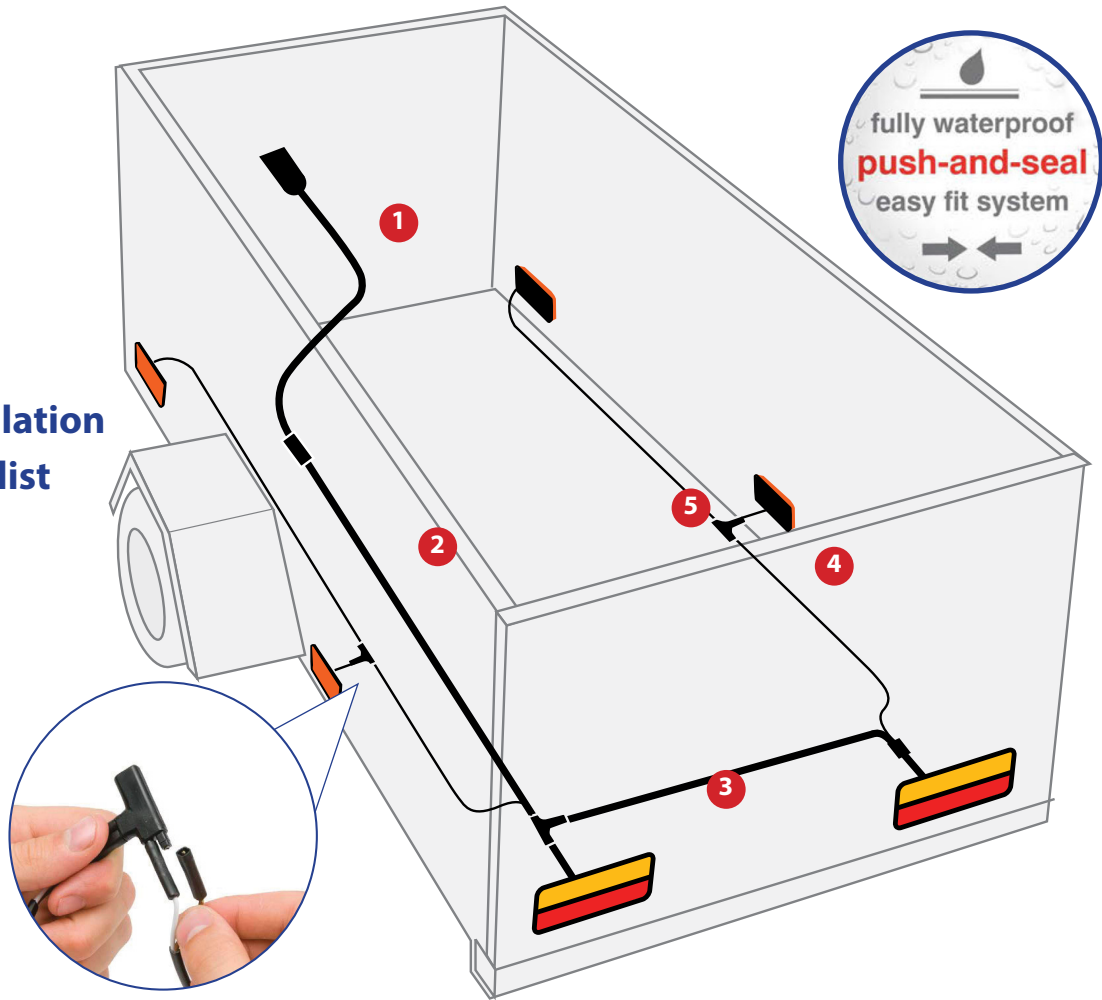

- 1 53248**
Cable 3.2ft / 1 M
with Trailer Plug



- 2 Chassis Cables**



Part No.	Length
53251	16 ft / 4.9 M
53252	24ft / 7.3 M
53253	26ft / 8.0 M

- 3 Tail Light to Tail Light Cables**

53249 6.2 ft / 1.9 M

53250 6.8 ft / 2.1 M



- 4 Marker Lamp to Marker Lamp**



Part No.	Length
53243	3.2ft / 1M
53244	6.5ft / 2M
53245	9.8ft/ 3M
53246	13.1ft / 4M

- 5 Marker Lamp To Marker Lamp Cable Connector**

53242 T Piece Connector



51760
P Clips 7.9mm





EASY FIT WIRING SYSTEM

Rear Lamps LED



51987
Rear Lamp LED 3 Function - Pack of (2) 12volt



52823
Rear Lamp LED 12V PAIR Small

LEDKIT1

Trailer Basic LED KIT Max Dimensions 23 ft x 7 ft **Kit Includes:**

- Rear Lamp LED 12V PAIR
- Cable 3.2ft / 1 M with Trailer Plug
- 24ft / 7.3 M Chassis Cable
- 2.1 Light To Light Cable



53255
Bezel for 51987 C/O
Number Plate Lamp



53256
Bezel for 52823 C/O
Number Plate Lamp



Marker Lamps LED

Side Marker Lamps with Plugs



Part No.	Size
53257	Amber
53258	Red
53259	White

Angled Rubber Marker Lamps



53264 Right Hand
53263 Left Hand

193mm x 169mm x 66mm



55355

Wireless LED Lighting Trailer Set

KEY FEATURES

Magnetic

Wireless connectivity

10h of Brightness

Multi-functional

4h to fully recharge



Marker Lamps



1629
Side Marker Lamp 12v (Single Contact)



1303
Lens Red for Side Marker Lamp



1310
Lens Clear for Side Marker Lamp



1649
Side Marker Lamp 12v (Orange Lens)



1302
Front Lamp (Flush Fitting)

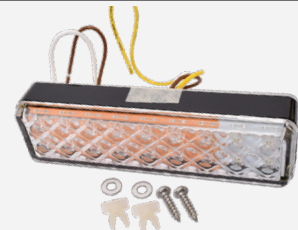

55688
Front Marker Lamp LED 12/24V
135mm x 38mm x 24mm



1266
Side Marker Lamp 100



512600
Side Marker Lamp Lens Amber



1624
Side Marker Lamp 12V 90°

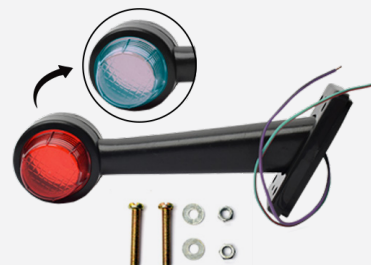

1589
Side Marker Lamp 12v

Junction Boxes



1329
Eight Way Junction Box



3795
Junction Box Six Way



53405
Junction Box 10 Way

Combination Lamps



1759
Rear Combination Lamp 12v Tapered **PAIR**
Lens is 2416



1716
Rear Combination Lamp 12v Flat **PAIR**
Lens is 2416



2040
Rear Lamp Combination - Rice Trailer



1903
Rear Lamp Combination

Combination Lamps

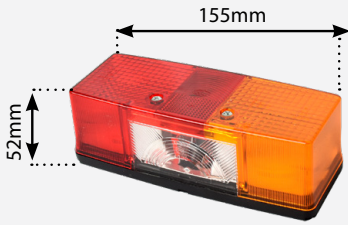

3646
Rear Lamp Left Hand with Number Plate
Lamp *Lens is 3648*

3647
Rear Lamp Right Hand with Number
Plate Lamp *Lens is 3649*



3646G
Rear Lamp Left Hand with Number Plate
Lamp

OE Ref: AL35176

3647G is Right Hand Lamp
OE Ref: AL32070

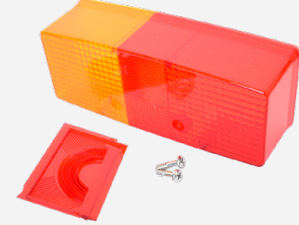

3648G
Left Hand Lens for 3646G



1767
Rear Lamp 12v



1541
Lamp Lorry Right Hand



55686
LED Rear Lamp Low Profile Stop Tail
Indicator 12/24v
131mm x 30mm x 8mm

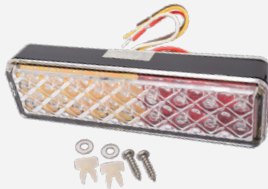

55687
LED Rear Lamp Stop Tail Indicator 12/24V
135mm x 38mm x 24mm



1350
Rear Lamp 4 Function
Lens is 1351



1519
Lamp Rear Indicator



62357
Lamp Vintage Type Round Indicator
168 Export Indicator & Stop &
Tail 81.4mm



55321
Rear Lamp With Stop Indicator &
Number Plate Lamp
OE Ref: 2ST003018-061



55322
Front Marker Lamp
OE Ref: 2BE003018-011

Number Plate Lamps



4234
Chrome Number Plate Lamp *100mm*



3633
Small Number Plate Lamp 300s



4233
Black Number Plate Lamp *100mm*



4846
Number Plate Lamp *87mm*



1232
Small Interior Light - *116mm x 50mm*

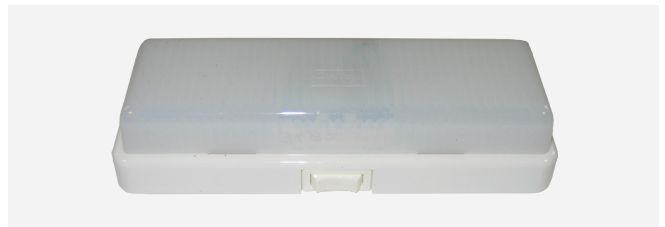

3487
Interior Lamp *200mm X 70mm*



4845
Licence Plate Lamp *82mm*

LED MARKER LAMPS

SIDE MARKER LAMPS LED
10/30 VOLT

73mm
57mm

Part No.	Size
51988	Amber
51989	Red
52813	White

MARKER LAMPS WITH BRACKETS
2 BARE WIRES 110MM X 64MM X 25MM

Part No.	Size
51927	Amber
51928	Red
51929	White

54846
LED SIDE MARKER LAMP
RED/WHITE

COBO front

54845
LED SIDE MARKER LAMP
RED/WHITE

COBO front

53099
Side Marker Lamp Trailer LED

53100
Bracket to Suit Side Marker Lamp 53099

LED LAMPS

Marker Lamps - Rubber

52880

Side Marker Lamp Rubber LED 12V
101mm x 82mm x 66mm

512600

Amber Side Marker Lamp Lens

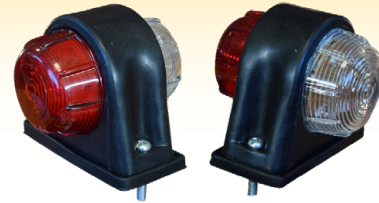

Angled Rubber Marker Lamp

51923

Right Hand 12V

51924

Left Hand 12V

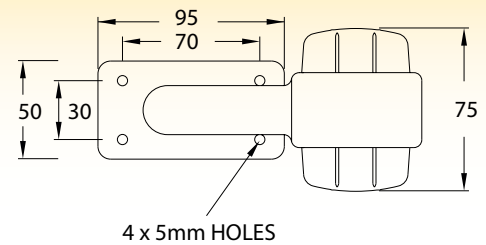

Combination Lamps

51990

Rear Lamp Round
LED 140mm



53622

Rear Lamp
Combination LED



53752

Rear Lamp LED 12V Pair Large
200mm x 90mm



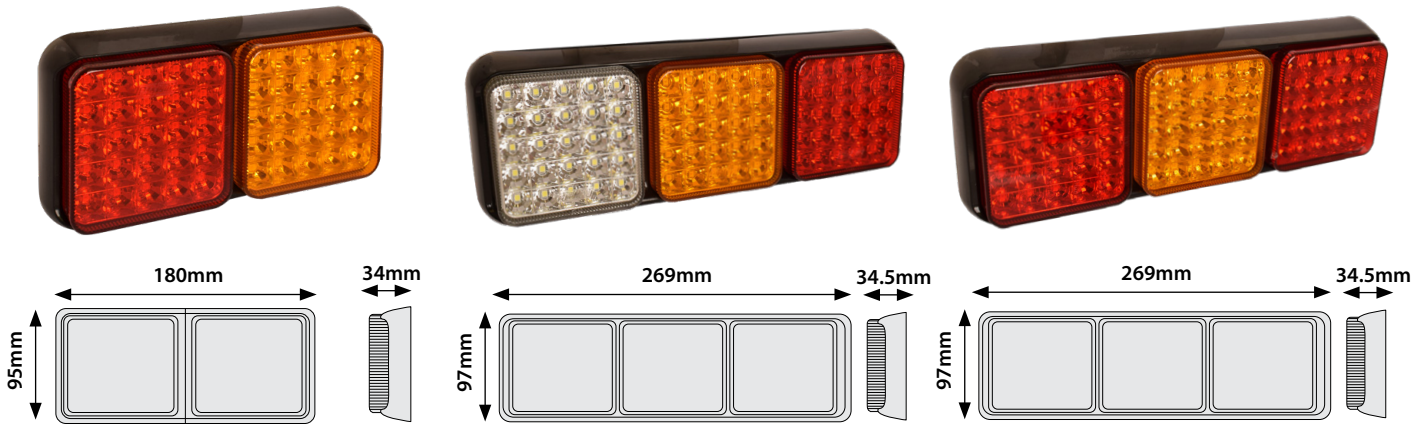

55201

Lamp Double Module 10/30V 40cm Cable
Suits Ifor Williams Trailer

55202

LED Reverse Lamp Triple Module 10-30V
40cm Cable - Ifor Williams Trailer

55203

LED Fog Lamp Triple Module 10-30V
40cm Cable Suits Ifor Williams Trailer

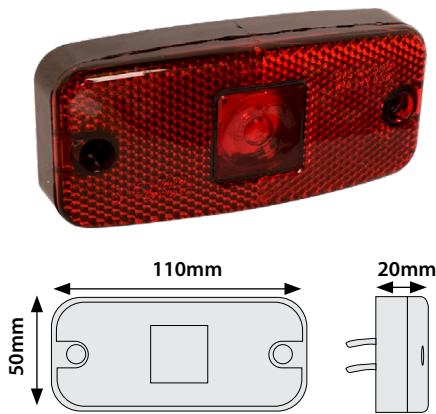

55194

LED Rear Red Marker Lamp 10/30V
21cm Cable



55193

LED Front Clear Marker Lamp 10/30V
21cm Cable



55192

LED Amber Side Marker Lamp 10/30V
21cm Cable

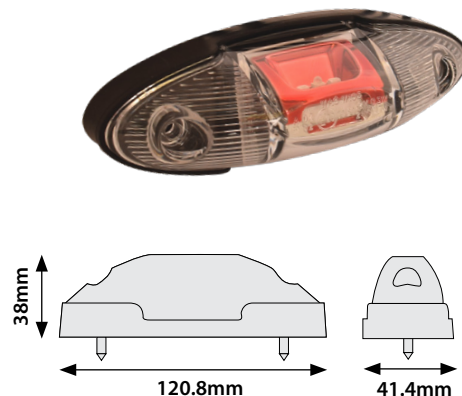

55195

LED Marker Lamp Red/White

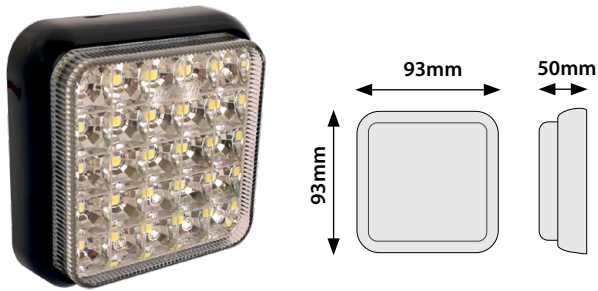

55210 LED Reverse Lamp 10-30V 40cm Cable

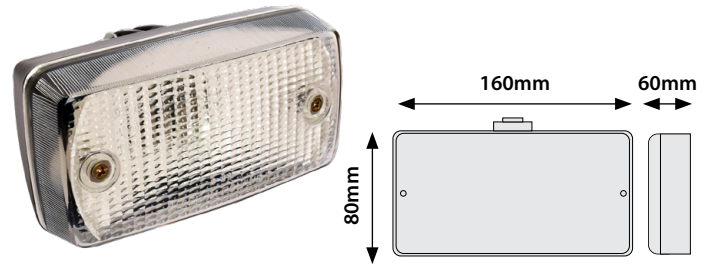

55216 Reverse Lamp 12V with Mounting Bracket Bulbs Included

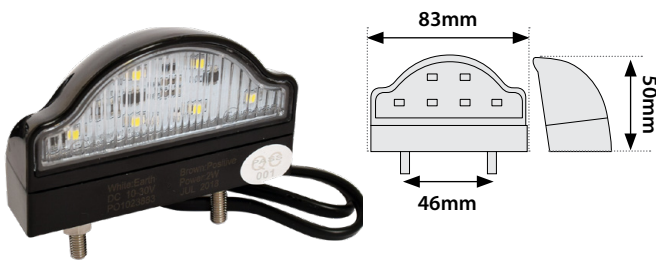

55211 LED Number Plate Lamp 10-30V 32cm Cable With Mounting Bolts

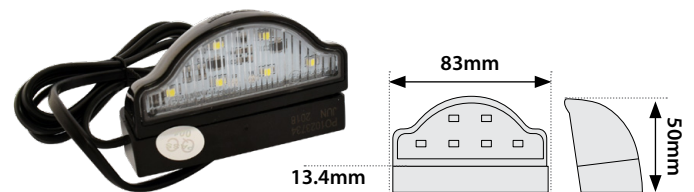

55212 LED Number Plate Lamp 10-30V 30cm Cable Clip On

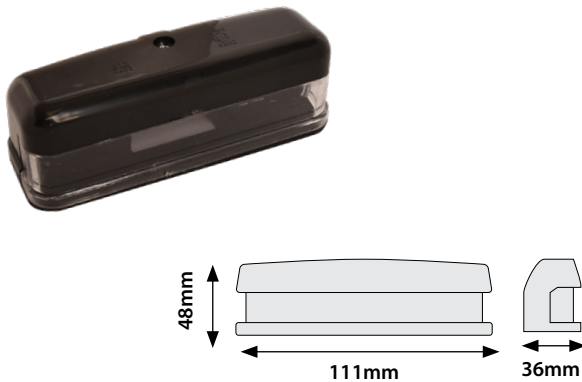

55217 Number Plate Lamp 12V With Studs & Bulbs Included



55218 LED Strobe Lamp 12W 12/24V

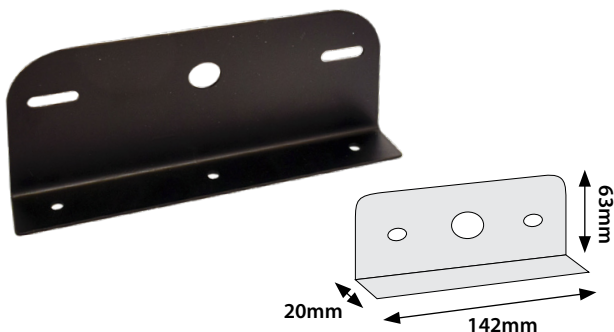

55220 Mounting Bracket 12mm Hole Diameter

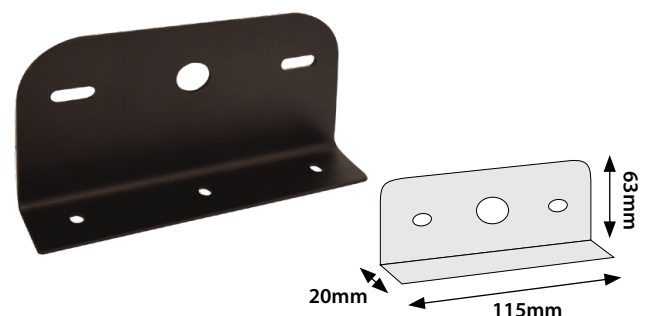

55219 Mounting Bracket For 55218 12mm Hole Diameter

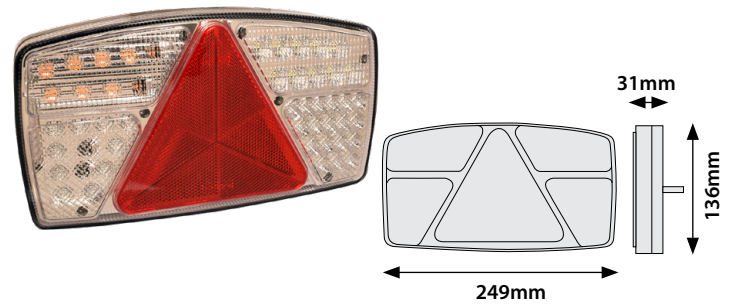
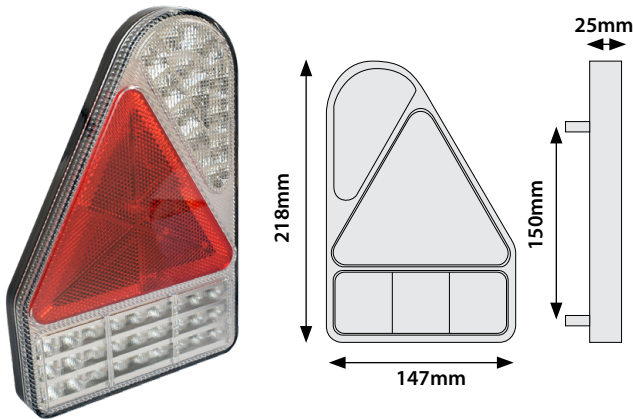

LED Combination Lamp Triangle Slimline Chrome 10/30V 45cm Cable

LED Combination Lamps 10/30V 54cm Cable

55207	Left Hand Lamp
55208	Right Hand Lamp

55204	Left Hand Lamp
55205	Right Hand Lamp

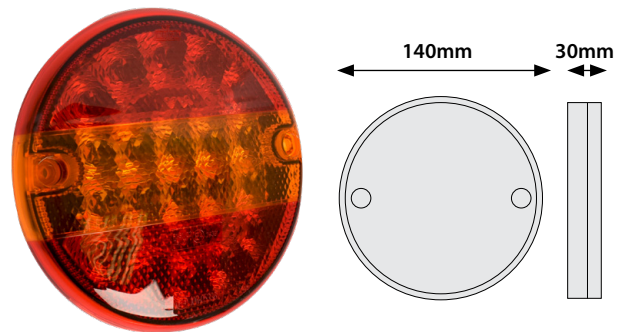
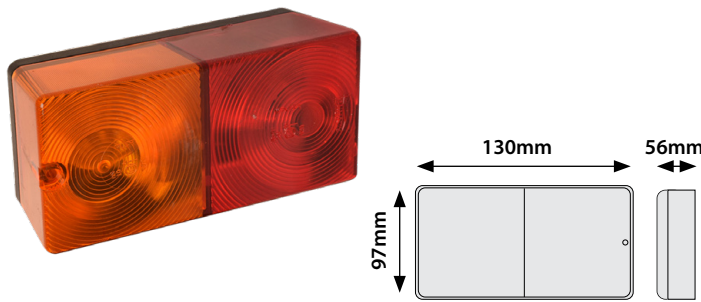

55214 Combination Lamp Rectangular 12V Bulbs Included

55206 LED Combination Lamp Round 9/30V Spade Connection

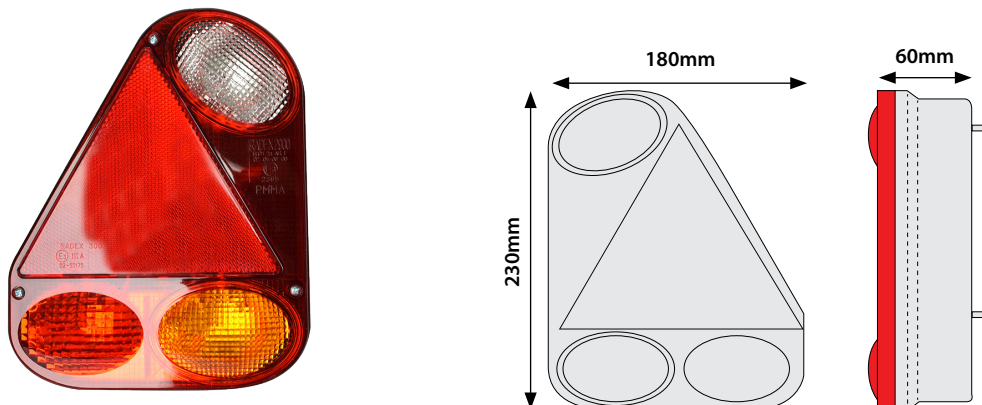

Rear Vertical Radex Combination Lamps - 5+4 Pin Quick Fit System

55191	Left Hand Lamp
-------	----------------

55190	Right Hand Lamp
-------	-----------------

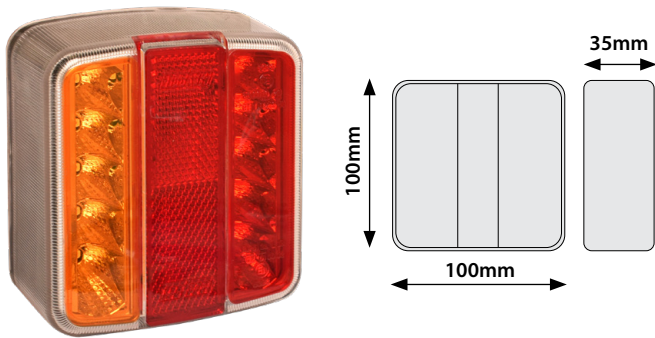

55196

LED Combination Lamp Square
12V 15cm Cable

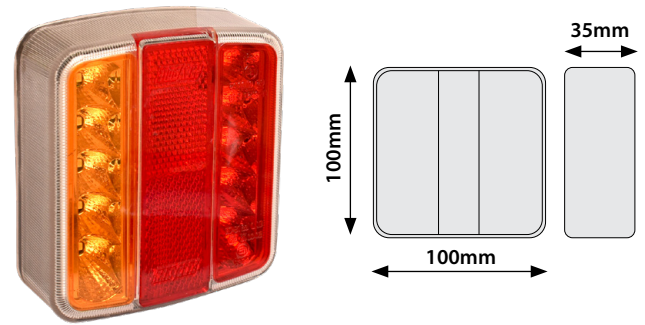

55197

LED Combination Lamp Square 12/24V 15cm Cable

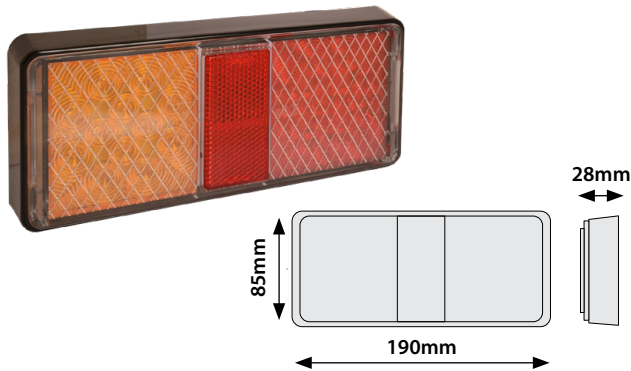

55199

LED Combination Lamp Rectangular 10/30V 30cm Cable

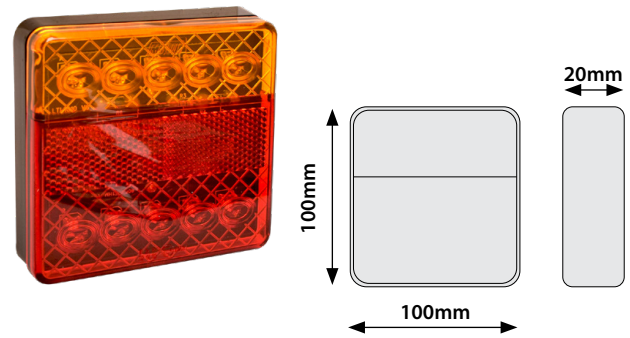

55198

LED Combination Lamp Square 12V 12.5cm Cable Slimline

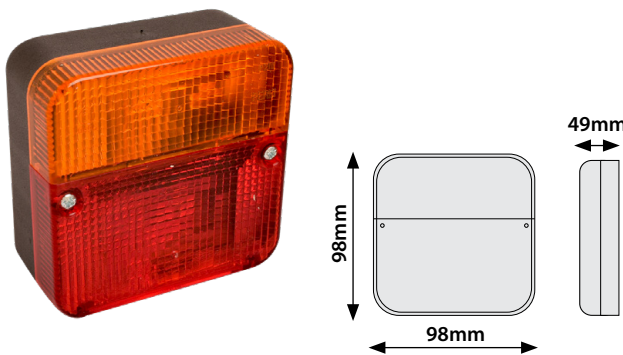

55213

Combination Lamp Square 12V Bulbs Included

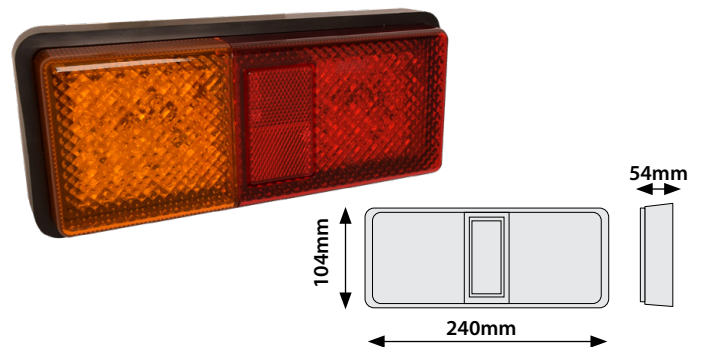

55200

Combination Lamp Rectangular EDPM Base 10-30V 40cm Cable

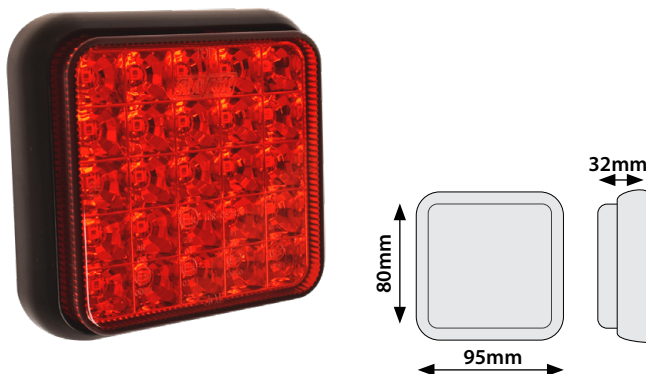

55209

LED Fog Lamp 10/30V 40cm Cable

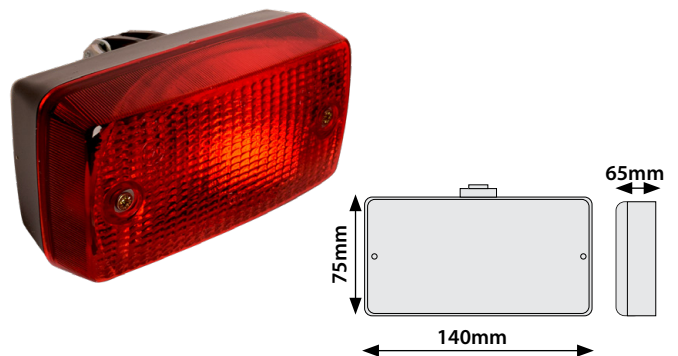

55215

Fog Lamp 12V With Mounting Bracket Bulbs Included

Single Pole



COBO
great

3457
Socket Single Pole 12 Volt 15 Amp



COBO
great

6616
Plug Single Pole 12V/15A for Power Point



51764
Socket Power Outlet Female 12V/15A



53762
Single Pole Angled Plug

3 Pin



COBO
great

6613
Socket 3 Pin - 2 Bolt Fixing



COBO
great

6626
Plug 3 Pin



COBO
great

6628
Socket 3 Pole - 4 Bolt Fixing



53588
Bracket Cobo Socket Angled



53589
Bracket Cobo Socket

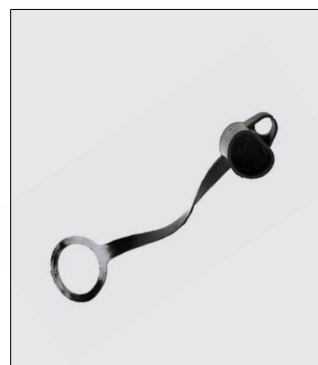

6644
3 Pin Plug Cover



51054
M5x35mm Socket Fixing Nut & Bolt

4 Pin



52612
Plug 4 Pin



52611
Socket 4 Pin

7 Pin



1224
Rubber Sealing Gasket 7 Pin Socket



55086
Tester 7 Pin Plug Socket 12V
9V Battery Not Included
OE Ref: S2297

7 Pin



3444
Trailer Socket 7 Pole Aluminium



3444G
Trailer Socket 7 Pin Aluminium Nickel Plated Pins



3445G
7 Pin Trailer Plug Aluminium Nickel Plated



3445
Plug 7 Pole Aluminium



51165
Trailer Socket & Plug 7 Pole

13 Pin



53911
Trailer Socket
Male - 13 Pin



53913
Trailer Socket
Female 13 Pin



53914
7 Pin to 13 Pin
Plastic Socket



53912
13 Pin to 7 Pin
Plastic Socket

Trailer Jockey Wheels & Parts

Trailer Jockey Wheels



51131
Trailer Jockey Wheel -
Rotolock 43mm Shaft



51132
Trailer Jockey Wheel
48mm Shaft



53409
Jockey Wheel Economy



53410
Jockey Wheel Autofold



51134
Cast Iron Clamp for 51131 43mm



51129
Trailer Jockey Wheel for 175 x 45



51463
Pad & Handle for Auto Head Reverse
Hitch 3500
Autohead is 51458



51303
Trailer Jockey Wheel Serrated
48mm Shaft Rotolock
Bracket is 53662



51130
Trailer Wheel for 210 x 75
to suit 51303



51154
Locking Handle and Pad
to suit 51303



4785
Trailer Safety Chain (16 Link) 1/2"





55324
Knob To Suit Bradley Jockey Wheels



54842
Bracket For Jockey Wheel 48mm

Trailer Heads

Part Number	Description	Weight	Shaft	Photo
51143	Trailer Head Double Lock - 4 Bolt	1.5 Ton	Bolt on top	
51141	Trailer Head 750kg Old Type	1.7 - 2.7 Ton	Bolt on top	
51268	Trailer Head 2.7 Ton 50mm X 48mm	2.7 Ton	50mm X 48 mm	
51453	Trailer Head for 51458 60mm Shaft	3.5 Ton	60mm X 60 mm	
51458	Auto Head Reverse Hitch 3500 Kgs	3.5 Ton	Bolt on top	

				
51124 Trailer Bellow 3.5 Ton	51123 Grommet Trailer Bellow 1.7 - 2.7 kg	51625 Coupling for 50mm box section	53052 Snaphook & Safety Lock 7 x 70mm	51633 Drawbar Spring Rating 14 Tonne

Quick Link Chain

Part No.	Size (mm)
53044	10
53045	12
53046	14

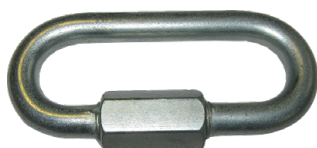

D Shackles & Pins

Part No.	A (mm)	B (mm)
2550	6	11
2551	8	18
2552	10	19
2553	11	20
2554	12	22
2555	16	35
2556	20	38
2557	22	40
2558	25	45

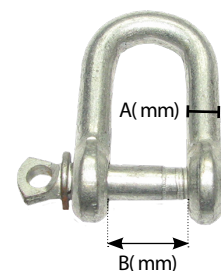

Hitch & Tow Hitch Parts

2490

Tow Hitch
Double Duty
3500Kg



3595

Trailer Hitch
with Mounting
Plate

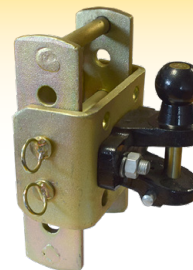

3811

12' Cranked Towing Ring 30mm Thick



6842

Trailer Hitch 12" Straight
Shank H/D 40mm Th



3788

Trailer Hitch Straight Shank 12" 30mm Thick



Ball Hitch Pins

1403

Hitch Pin and
Ball 1 1/4"

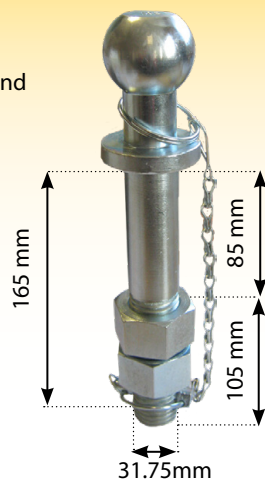

3642

Ball Hitch Pin &
Chain 7 1/2" x 7/8"

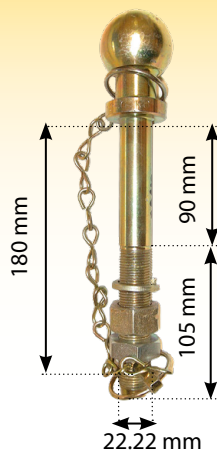

4672

Hitch Ball 7
1/2" x 1" Pin &
Chain

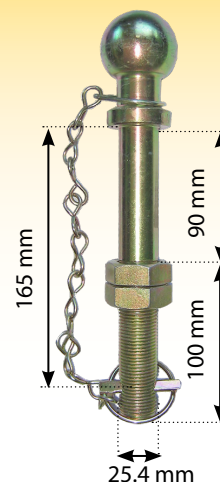

1386

Ball Hitch
max 1250kg

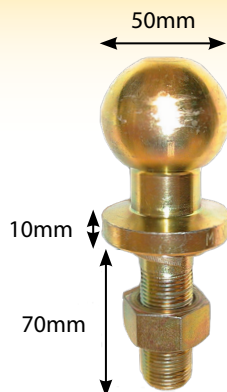

Thread - 7/8 UNF

53480

Ball Hitch
max 500kg

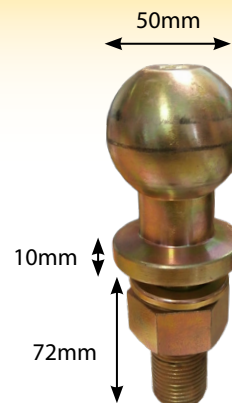

Thread - 3/4 UNF

Drawbar Locks



51126
Trailer Lock Barrel



51626
Trailer Anti-theft Lock

Breakaway Cable

Braked trailers must be fitted with breakaway cable. This cable will apply the hand brake if the trailer becomes detached during towing. It is recommended that it is inspected regularly, and replaced if defects are visible.

51125
Trailer Breakaway Cable 41"

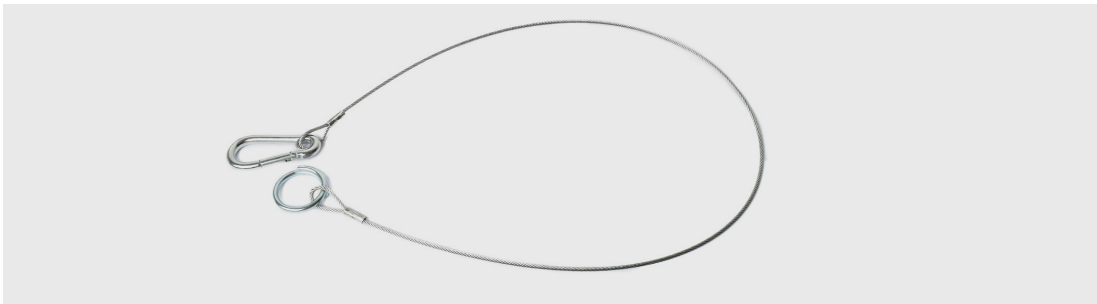

Drawbar Dampers

Regularly inspect brakes for adjustment to prevent premature failure of damper.

51460
Trailer Damper for Bradley Hitch 1.7K



51173
Trailer Damper 2.5 Ton for 51457
Overall length 377mm



51105
Trailer Damper 3.5 Ton for 51458



Axle

Hub Caps

Part Number	Description	Hub Size
51429	Hub Cap	72mm
51467	Hub Cap	90mm
51574	Hub Cap	100mm
51428	Hub Cap for F90L410	110mm
51575	Hub Cap New Generation	120mm
51809	Dust Cap <i>Stub Axle= 51452</i>	50mm



Stub Axles



51452
Stub Axle U Braked 38mm 100PCD
Dust Cap is 51809



51448
Stub Axle 203 x 40 A Rev
4 x 5.5

Bearings



52380
Wheel Bearing Ifor Williams One Piece OD 76mm ID 42mm
Depth 39mm CT HB DP GD LM LT TA TT



18590/20
Trailer Bearing Ifor Williams

Nuts & Bolts

Wheel Nuts

Part No.		Size	
51438		M12	
51455	Conical	M16	
51436	For Stub Axle	M20	
51437	For Braked Stub	M22	
51156		3/8"	
51435	Chrome for Stub	M18	
54875	Wheel Nut	M18	

Wheel Studs

Part No.		Size	
51157		M12	
51158		M16	
51432	For Stub	M20	
51434	For Braked Axle	M22	
51456		3/8"	
51433	for Dual Wheel 20mm	M20	
54874	Wheel Stud 18mm	M18	

Washers



51935
Conical Washer 20mm



54876
Washer To Suit Wheel Stud 54874

Suspension

Springs



511301
Spring for Williams Single Leaf
14mm hole

54847
Leaf Spring Bush for Williams
Fits 511301 & 511302

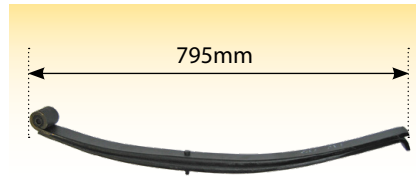

511302
Spring for Williams Double Leaf
12.5mm hole
Bush to fit is 54847

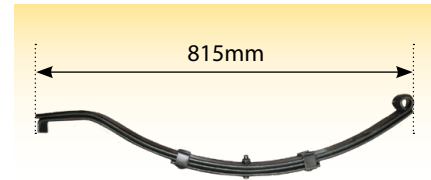

51829
Multi Leaf Trailer Spring 3 Leaf Spring



51443
Multi Leaf Trailer Spring 4 Leaf Spring

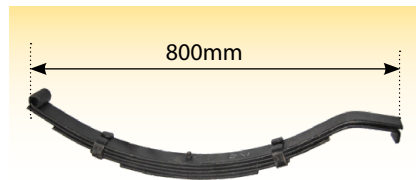

51444
Multi Leaf Trailer Spring 5 Leaf Spring

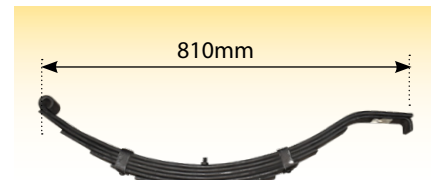

51650
Multi Leaf Trailer Spring 7 Leaf Spring

Eye Bracket & Bolt

51446
Leaf Spring Bracket & Bolt
Suspension Unit



U Bolt with Plate

51445
U Bolt c/ol Plate & Nuts 150mm
1/2" UNC

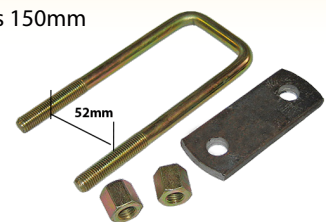

Suspension Units

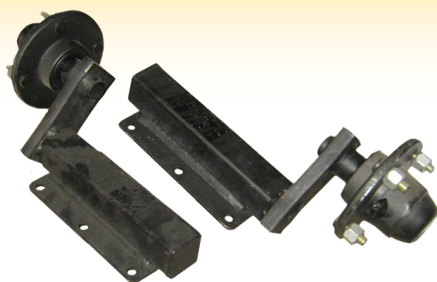

51135
Trailer 350kg Suspension Unit Per Pair 4"
PCD Hubs 4 Stud Grease Nipples

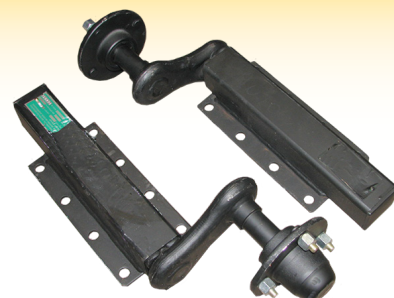

51828
Trailer 750kg Suspension Unit Per Pair 4"
PCD Hubs 4 Stud Grease Nipples

Mudguard Flaps



1488

Mudguard Trailer Tandem 8" x 68" - PAIR

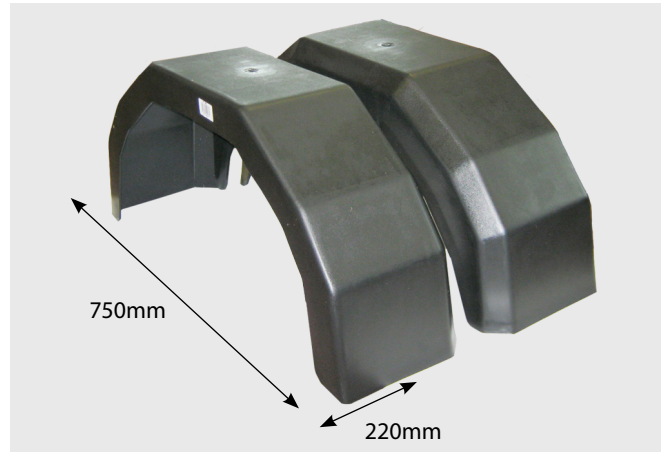

1496

Mudguard Trailer 13" Wheel - PAIR

Wheels



51442

Wheel Rim with 165 x 13 Tyre
(4 Stud) 5.5 pcd



53103

Wheel Rim Complete with Tyre
145 X 10 Suits 51135 & 51828

Trailer Parts

Spring Bolts

Part No	Diameter	1	2
53657	Ø 10mm	44mm	70mm
53659	Ø 16mm	100mm	132mm
53660	Ø 19mm	85mm	116mm
53661	Ø 22mm	95mm	112mm
2547	Ø 13mm	35mm	65mm

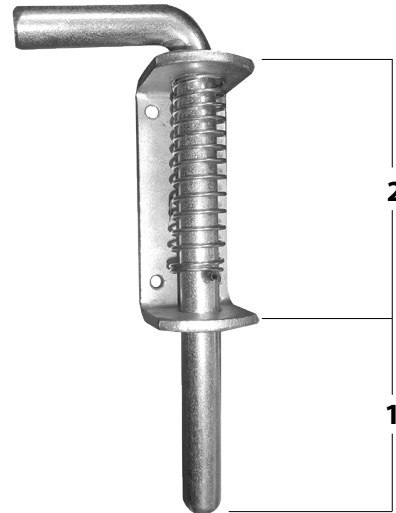

53088

Lock Rope Ring
Recessed



3867

Cattle Trailer Fastener



1583

Antiluce



4428

Antiluce



4030

Trailer Side Board
Fastener



2496

Antiluce



3804

Weld On Antiluce
Fastener

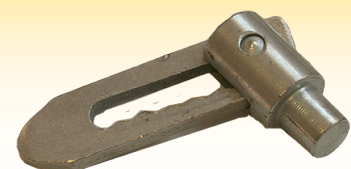

Brake Shoes

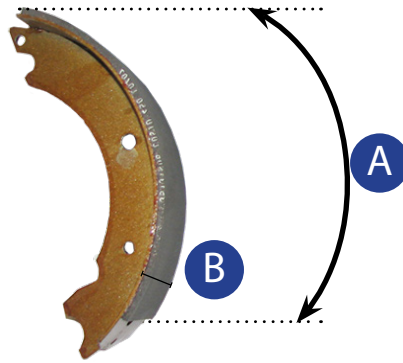

Part Number	Description	Qty	A	B	Photo
51100	Brake Shoe for lfor Williams 6"	Set of 4	170mm	50mm	
51295	Brake Shoe Set 8" Suits auto reverse system	4 Pieces 2 Pairs	200mm	50mm	
51171	Brake Shoe (Pair)	4 Pieces 2 Pairs	203mm	40mm	
51294	Brake Shoe Set 10"	4 Pieces 2 pairs	250mm	40mm	

Brake Cables

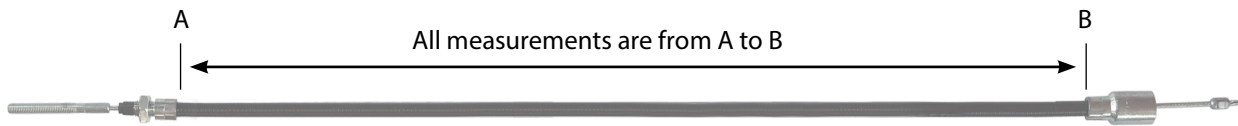

51167

Brake Cable **1100mm** Threaded



51296

Trailer Brake Cable **1200mm** Threaded



51462

Trailer Brake Cable **1200mm**



51170

Brake Cable **1600mm** Threaded



53081

Trailer Brake Cable **1800mm** Threaded

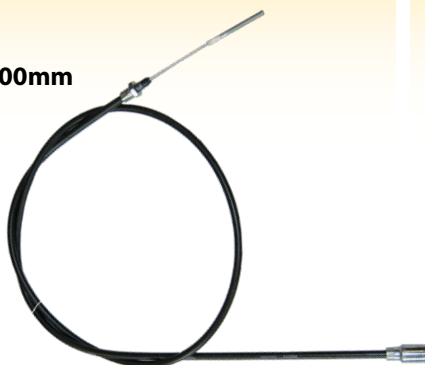

51638

Cable Shell

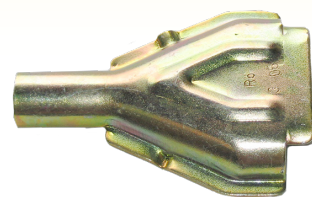

Trailer Brake Parts

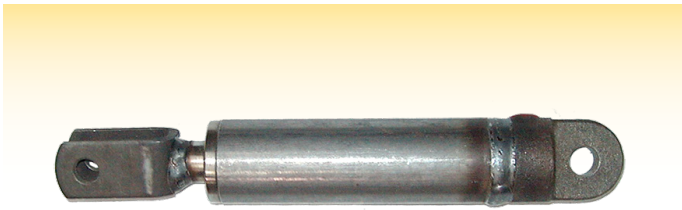

4611
Trailer Brake Ram Cylinder 25mm
285mm centres 70mm Stroke
with Internal Return Spring

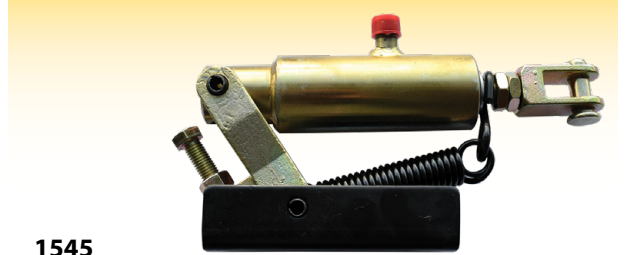

1545
Trailer Brake Ram with Bracket

51236		Spring for 1545 Brake Ram
--------------	--	------------------------------

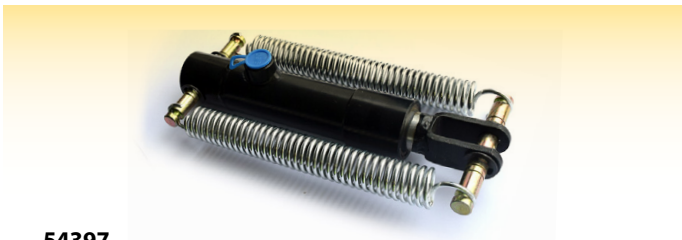

54397
Trailer Brake Ram 30mm
Double Spring Return
75mm Stroke

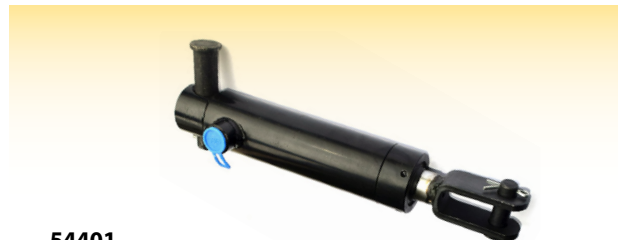

54401
Trailer Brake Ram 25mm
75mm Stroke

HYDRAULIC PNEUMATIC BRAKE ACTUATOR MOUNTINGS

54398	SIZE - 76.2MM	AIR POT TYPE 12
	RAM - 25MM	AIR POT PORT - 16MM
54399	SIZE - 120.7MM	AIR POT TYPE 16
	RAM - 25MM	AIR POT PORT - 16MM
54400	SIZE - 120.7MM	AIR POT TYPE 20
	RAM - 30MM	AIR POT PORT - 16MM

PNEUMATIC BRAKE ACTUATOR CHAMBERS

54405 T20
54404 T24
54403 T30

Brake Springs & Kits

52833
Backing Plate Spring Kit 4
Stud Hub



51297
Spring Knott
8" Long Hook



52834
Brake Spring Kit 5
Stud Hub



Decals

53680
Decal
30kmph



53681
Decal
40kmph



53682
Decal
50kmph



53683
Decal
60kmph



Straps And Winches



5077
Cargo Strap 5 Ton x 8 mtr

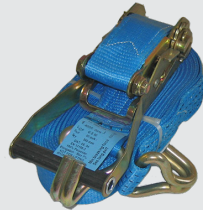

5059
Cargo Strap 5 Ton x 10 mtr



5099
Cargo Strap 5 Ton x 12 mtr

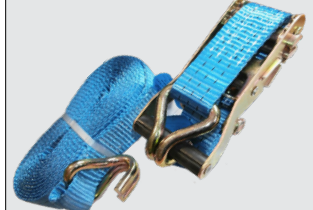

53372
Cargo Strap 3 Ton x 5 mtr



51910
Engine Sling 2 Ton x 2 Metre
Web Type



51911
Engine Sling 2 Ton x 3 Metre
Web Type



51912
Engine Sling 2 Ton x 4 Metre
Web Type



51913
Engine Sling 3 Ton x 5 Metre
Web Type

Brake & Clutch Fluid



2448
Brake Hydraulic Oil 1Ltr LHM Mineral



2445
Brake & Clutch Fluid Dot4 1 Ltr



61254
Trailer Brake Valve Repair Kit - 16mm Seal
Fits 300 600 3000 5400 6100 6200 8100



1353
Strap Winch 500Kg (6MTS STRAP)

Bulbs

H1 Halogen		H3 Plough		H4 Halogen		H7	
3102	12V h1 55w	1003	12V H3 55w	4324G	12V H4 80/100W		
3550	24V h1 55w	1003G	12V H3 55w	3909	12V h4 60/55W		
		3678	24V H3 70w	3909G	12V h4 60/55W	51715	H7 55W
				1111	12V h4 60/55w - P45T	51715G	H7 55W
				1111G	12V h4 60/55w - P45T		

H1 Halogen		H4 Halogen		H7 Halogen	
53645	12V 55W H1 PAIR 80% Brighter	53647	12V 55W H4 PAIR 80% Brighter	53649	12V 55W H7 PAIR 80% Brighter
53646	12V 55W H1 PAIR 120% Brighter	53648	12V 55W H4 PAIR 120% Brighter	53650	12V 55W H7 PAIR 120% Brighter

1413
12v 21/5w Stop & Tail

1412
12v 21w Indicator

1360
12v 50/40w Double
Contact P/F

4205
12v 21/5w Stop/Rear Old
Type Ford Q Cab

53424
Bayonet 10W 12V

3586
12v 5w Double
Contact S/F

4499
12v 21w Double
Contact

1361 12v 5w Single
Contact

3160 24v 5w Double
Contact S.F

Bulbs

1316
12v 45/40W



3196
12v 3w Capless



4657 12V 10W Bulb (30mm)
1359 12 V 5W Bulb (38mm)



1347 Bulb 12v 4w
4509 Bulb 12v 2w



1971
Bulb Holder Single Contact



1965
Bulb Holder Double Contact



41841
Bulb New Holland TS100A
Work Lamp
Oe Ref: 44995162



61573
Bulb 300's Dash Light Panel
OE: Ref: 3476232M1



61135
Bulb 12v 2w 4200
6100 8100 Philips





61661
Bulb 3000 3100
3600 Dash Light







59805
Bulb 12v 50w John
Deere 6000 & Ford



Electrical Cable

Part No.	Description	Unit	
1810R	4.8mm x 2.4mm Heat Shrink	20 mtr roll	
1811	6.4mm x 3.2mm Heat Shrink	mtr	
1811R	6.4mm x 3.2mm Heat Shrink	15 mtr roll	
1812	9.5mm x 4.8mm Heat Shrink	mtr	
1812R	9.5mm x 4.8mm Heat Shrink	15 mtr roll	
1814	19.1mm x 9.5mm Heat Shrink	mtr	
1814R	19.1mm x 9.5mm Heat Shrink	10 mtr	
1141	Blue Heat Shrink Butts (Suitable for Cables 1.5mm ² - 2.0mm ²)		
1142	Yellow Heat Shrink Butts (Suitable for Cables 3.0mm ² - 6.0mm ²)		



CORE CABLES

Part No.	Description	Colour	
55440	Core Cable 1 x 2.5mm 10mtr Roll	Blue	
55441	Core Cable 1 x 2.5mm 10mtr Roll	Yellow	
55442	Core Cable 1 x 2.5mm 10mtr Roll	Black	
55443	Core Cable 1 x 2.5mm 10mtr Roll	Red	
55444	Core Cable 1 x 2.5mm 10mtr Roll	Brown	

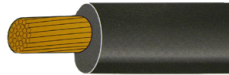
Part No.	Thickness (mm)	Length (Mtr)	Colour	
1 Core Cable				

51161BK	4.5	10	Black	  Cross Section
51161	4.5	10	Red	
3380BK	4.5	30	Black	
3380R	4.5	30	Red	

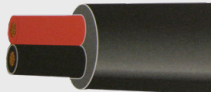
2 Core Cable (Round Twins)				
-----------------------------------	--	--	--	--

51162	2 x 1	10	Black Round	  Cross Section
51963	2 x 4.5	30	Black Round	
51964	2 x 4.5	10	Black Round	

2 Core Cable (Flat Twins)				
----------------------------------	--	--	--	--

3637R	2 x 2	30	Black Flat	  Cross Section
51961	2 x 4.5	10	Black Flat	
51962	2 x 4.5	30	Black Flat	

3 Core Cable				
---------------------	--	--	--	--

51845	3x3	10	Black	 Cross Section
--------------	-----	----	-------	--

Part No.	Thickness (mm)	Length (Mtr)	Colour	
4 Core Cable				
2629R	4 x 1	30	Black	  Cross Section
2629M	4 x 1	100	Black	
51846	4 x 3	10	Black	
7 Core Cable				
1053R	6 x 1 1 x 2	30	Black	 Cross Section
51164	6 x 1 1 x 2	10	Black	
13 Core Cable				
53909	8 x 1.5mm + 5 x 2.5mm	10	Black	 Cross Section
53910	8 x 1.5mm + 5 x 2.5mm	10	Black	
Battery Cable				
2631	50	10	Black	
2636	50	10	Red	
Clips				
51758	P Clips 4.8mm			
51759	P Clips 6.4mm			
51760	P Clips 7.9mm			
51761	P Clips 9.5mm			
Wire Stripper				
3640	Wire Stripper			

Cable Connectors

Part No.	Description	
4175	Connection 6.3 x 0.8 Female	
4176	Connection 6.3 x 0.8 Male	
4177	Connection 1 Way Female	
4178	Connection 1 Way Male	
4179	Connection 2 Way Female	
4180	Connection 2 Way Male	
4181	Connection 2 Way Female	
4182	Connection 2 Way Male	
4183	Connection 3 Way Female	
4184	Connection 3 Way Male	
4185	Connection 4 Way Female	
4186	Connection 4 Way Male	

Terminals

Part No.	Description	
1102	6.3mm Red Piggy Back Terminal Suitable for 0.5 mm – 1.5 mm Cable	
4559	Red Male Bullet Terminal	
3891	Red Male Spade Terminal 6.3 x 0.8 mm Suitable for .5 - 1.0 mm Cable	
4560	Red Female Bullet Terminal	
1107	Blue Piggy Back Terminal 6.3mm Suitable for 1.5 mm – 2.5 mm Cable	
3382	Blue Round Terminal M6 Suitable for 1.0 - 2.5 mm Cable	
2163	Spade Terminal - Blue Suitable for 1.0 - 2.5 mm Cable <i>100 in a box</i>	
3542	Blue Medium Spade Terminal Suitable for 1.0 - 2.5 mm Cable	
3381	Blue Male Spade Terminal Suitable for 1.0 - 2.5 mm Cable	
3628	Blue Bullet Terminal 5mm Suitable for 1.5 mm – 2.5 mm Cable	
4514	Male Bullet Terminal Suitable for 1.0 - 2.5 mm Cable	
3716	Small Blue Insulated Female Spade Terminal <i>100 in a box</i>	
3383	Round Terminal M10 Suitable for 1.0 - 2.5 mm Cable	
2166	Yellow Round Terminal M6 Suitable for 4.0 - 6.0 mm Cable	

Terminals

Part No.	Description	
2167	Yellow Round Terminal M8 Suitable for 4.0 - 6.0 mm Cable	
2168	Yellow Round Terminal M10 Suitable for 4.0 - 6.0 mm Cable	
1933	Female Push On Terminal 9.5mm	
1110	Yellow Piggy Back Terminal 6.3mm Suitable for 4.0 - 6.0 mm Cable	
2164	Spade Terminal - Yellow Suitable for 4.0 - 6.0 mm Cable	
2632	Terminal 9.5mm Female Pre-Insulated Suitable for 4.0 - 6.0 mm Cable	
2209	Spade Terminal H/D Small Insulated Suitable for 4.0 - 6.0 mm Cable	
52903	Pre Insulated Terminal Kit 160pcs	
52902	Pre Insulated Terminal Kit 260pcs	
52906	Cable Assy 1 x Female 2 x Male Yellow	

SUPER SEAL CONNECTOR KITS

- 54411** 1 WAY KIT
- 54412** 2 WAY KIT
- 54413** 3 WAY KIT
- 54414** 4 WAY KIT
- 54415** 5 WAY KIT
- 54416** 6 WAY KIT



1318
Blue Scotch Hook
Connector

Radio Fuses

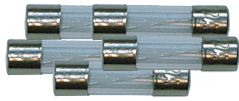

1074	1 Amp	Radio Fuse
1075	2 Amp	Radio Fuse
1026	4 Amp	Radio Fuse
1087	5 Amp	Radio Fuse

Glass Fuses



2928	10 Amp	Glass Fuse
2929	15 Amp	Glass Fuse
2640	20 Amp	Glass Fuse
1939	25 Amp	Glass Fuse
2641	30 Amp	Glass Fuse
2642	35 Amp	Glass Fuse

Ceramic Fuses



1935	8 Amp	Ceramic Fuse
1357	16 Amp	Ceramic Fuse
1388	25 Amp	Ceramic Fuse

Strip Fuses

52923	30 Amp	
52924	40 Amp	
52925	50 Amp	
52926	60 Amp	
52927	80 Amp	

Glass Fuse- Pack



51285
Fuses Assorted Pack Glass (25 pcs)

Mega Fuses

52929	100 Amp	Yellow	
52933	200 Amp	Blue	

Blade Fuses

2156	7.5 amp	Brown	
2159	10 amp	Red	
2174	15 amp	Blue	
2160	20 amp	Yellow	
3612	30 amp	Green	

Maxi Blade Fuses

55656	50amp	
55655	80amp	
55654	100amp	



51047
Fuses 10 per pack Assortment

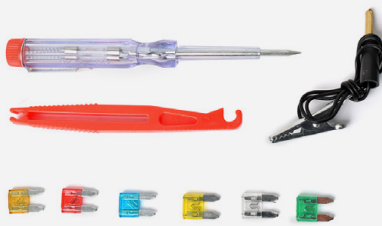

52900
Fuse Mini Blade Tool Kit 90pcs



53598
Fuse Blade & Tool Kit 93pcs
Includes Tester and Removal Tool



51498
Fuses Box of 12 Assorted

Fuse Holders



3639
Fuse



922108
Fuse Holder Inline + 8A
Ceramic Fuse



1072
Fuse Holder
with Wiring



3635
Fuseblade
Extractor/Tester

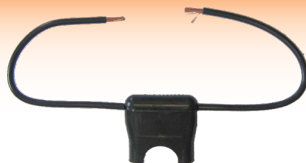

2152
Fuseholder
20amp Blade

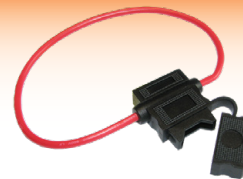

51426
Fuse Holder & Wire Black



3613
Fuse Holder Blade Splash Proof



3638
Fuse Holder

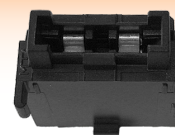

2154
Fuseholder 2 x
6.3mm Blade

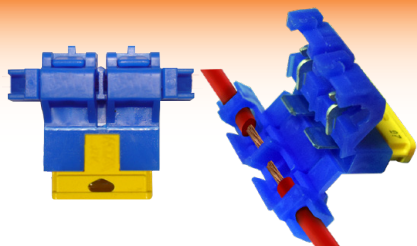

54155
Fuseholder Kit- In Line - Self Tap

Includes 20 Amp Fuse
Easily installed, easily removed

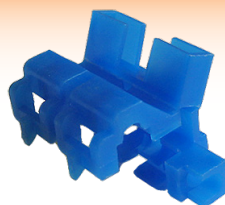

2155
Fuseholder In Line Wire
Holder



2208
Fuseholder 6.3mm Blade

Cable Ties

51838 Cable Clips Nylon
5MM Pack of 50



51857 Cable Clips Nylon Medium 8mm

51856 Cable Clips Nylon Large 14mm
Pack of 50

3717
Cable Ties 140 x 3.6mm

1238
295 x 4.8mm

3538
370 x 4.8mm

2646
370 x 7.6mm



1841
Insulating Tape
20mtr. 19mm

1840
Insulating Tape
33mtr.19mm Black

1842
Insulating Tape 20mtr.
25mm Black

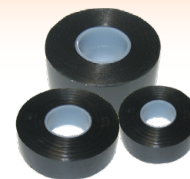

Fuseboxes



51981
Fusebox 4 Way
Complete



2157
Fusebox 6 Way
Complete



3703
Fusebox 6 Bank



53763
Fusebox With Cover
Negative Busbar

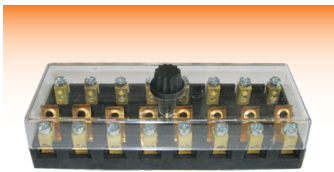

62590
Fusebox 8 Way



7291
Fusebox 110-90 12 Way



2158
Fusebox 265 275 290
8 Way Complete

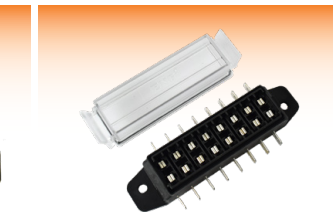

2161
Fusebox 8 Way
Complete



54888
Fuse Box 10 Pole With Black Cover



62704
Fusebox 13 Way



62712
Fusebox 14 Way



62713
Fusebox 15 Way

Part No.

54961	Fuse Box 8 Poles Transparent Cover
54962	Fuse Box 10 Pole Transparent Cover
54963	Fuse Box 12 Pole Transparent Cover
54964	Fuse Box 12 Pole Black Cover

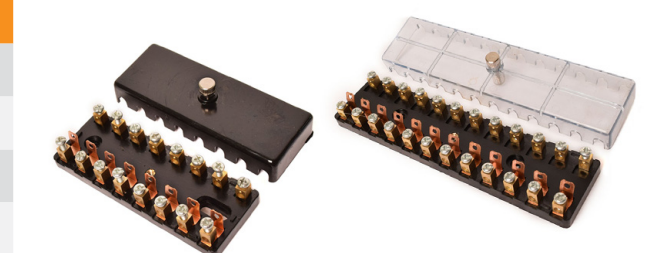

Relay Tester Probe

55170
Relay Tester Probe



Circuit Tester

3452
Hella Circuit Tester



Multi Meter

54780
Multi Meter
LCD Display DC/AC
Voltage CA2



YUASA

BATTERIES



59337
920Amp Battery 12V 110AH
 John Deere 4 Cyl Case MX Ford 2000 3000



1567
680Amp Battery 663 110AH
 L: 345 H: 210 W: 165



1389
1000Amp Battery 120AH



1459
680Amp Battery Ford Type 622 130AH
 L: 510 H: 185 W: 215



1334
630Amp Battery 069 70Ah
 L: 255 H: 200 W: 165



62793
800 Amp Battery G3



59354
1000Amp Battery 12V 170AH
 John Deere 6 Cyl Valmet



2566
640Amp Battery Type 067TE 70AH
 L: 270 H: 175 W: 165



3117
800Amp Battery Fiat Type 140AH
 L: 410 H: 200 W: 185



1568
720Amp Battery 655 High 125AH
 L: 345 H: 255 W: 165



3214
650Amp Battery YUASA 4200 6200 672A
 75AH L: 275 H: 185 W: 175

POWER PACK



54685
 12V 20A/H 400AMP



1392
 Battery Charger 12V - 12 Amp



3584
 Battery Charge 12/24V 12 AMP Battery
 Capacities 30-180AH



1397
 Battery Charger 12V 8 Amp Battery
 Capacities 20-90 AH

BATTERY & ALTERNATOR TESTER



55639
Battery & Alternator Tester



55640
Paper Rolls for Battery & Alternator Tester

BATTERY CABLES



Part No.	LENGTH	TYPE
54802	2000MM	Negative 70MM BLACK
54803	2000MM	Positive 70MM RED
54804	1300MM	Negative 70MM BLACK
54805	1300MM	Positive 70MM RED
54806	1100MM	Positive 70MM RED
54807	1100MM	Negative 70MM BLACK
54808	900MM	Positive 70MM RED
54809	900MM	Negative 70MM BLACK



Part No.	Lenght
Red Battery Cables (+) 50 mm	
51600	450
3528	900
1151	1100
51604	1300
51602	2000



CROSS OVER WITH EYE TERMINAL

Part No.	Description
55326	1200mm Negative
55327	1200mm Positive
55328	1000mm Negative
55329	1000mm Positive
55330	750mm Negative
55331	750mm Positive
55332	500mm Positive
55333	500mm Negative



Part No.	Lenght
Black Battery Cables (-) 50 mm	
51601	450
3529	900
1152	1100
51605	1300
51603	2000

Battery Accessories

Jump Leads

Part No.	Description
2654	Jump Lead 5mtr Cond.Size 20mm
2655	Jump Lead 5mtr Cond.Size 35mm
2656	Jump Lead 5mtr Cond.Size 50mm



Battery Cable Roll

2631
Black Battery Cable 10 Mtr Roll
 50mm

2636
Red Battery Cable 10 Mtr Roll
 50mm

Clamps

2169
 Black Clamp **500 Amps** (35/50mm Cable)

2170
 Red Clamp **500 Amps** (35/50mm Cable)

2924
 Clamp **300 Amps** 50mm Cable Black

2925
 Clamp **300 Amps** 50mm Cable Red

51811
 Crocodile Clamp Small

4554
 Black Clamp - Small **220 Amps** 16mm Cable



TWIST COMPRESSION BATTERY TERMINALS

IDEAL FOR FIELD REPAIRS / EASY TO INSTALL / CORROSION RESISTANT



POSITIVE POLARITY BATTERY TERMINALS +

Part No.	CABLE SECTION
55111	35MM ²
55112	50MM ²
55113	70MM ²

NEGATIVE POLARITY BATTERY TERMINALS -

Part No.	CABLE SECTION
55114	35MM ²
55115	50MM ²
55116	70MM ²

ASSEMBLY INSTRUCTIONS



1.
Cut the old terminal and strip off the cable jacket approximately 30mm length.

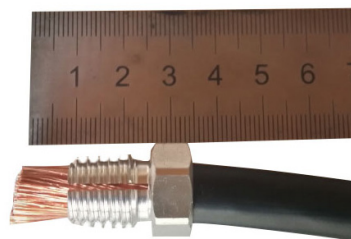

2.
Insert the stripped cable into the TWIST nut, taking care that it sticks out 8/10mm beyond the nut.
Tighten turning the terminal body keeping the nut still.



POSITIVE POLARITY BATTERY TERMINALS +



CABLE RIGHT EXIT

Part No.	CABLE SECTION
55099	35MM ²
55100	50MM ²
55101	70MM ²

CABLE LEFT EXIT

Part No.	CABLE SECTION
55102	35MM ²
55103	50MM ²
55104	70MM ²

NEGATIVE POLARITY BATTERY TERMINALS -

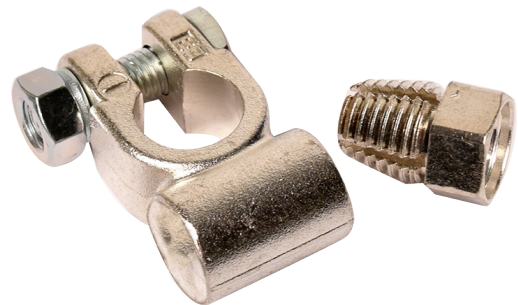
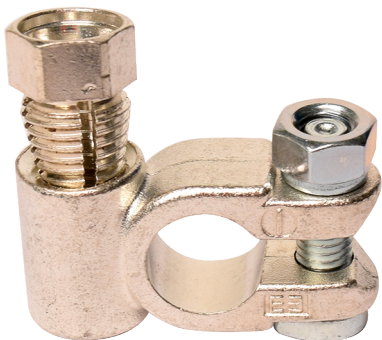

CABLE RIGHT EXIT

Part No.	CABLE SECTION
55105	35MM ²
55106	50MM ²
55107	70MM ²

CABLE LEFT EXIT

Part No.	CABLE SECTION
55108	35MM ²
55109	50MM ²
55110	70MM ²

Batteries & Accessories

Battery Terminals

52936 Battery Terminal Stud & Nut 17x10mm **Positive**

52937 Battery Terminal Stud & Nut 17x10mm **Negative**

52938 Battery Terminal Stud & Nut 30x10mm **Positive**

52939 Battery Terminal Stud & Nut 30x10mm **Negative**

1013 Battery Terminal **Negative**

1014 Battery Terminal **Positive**

BATTERY TERMINAL STUD & NUT



BATTERY TERMINAL

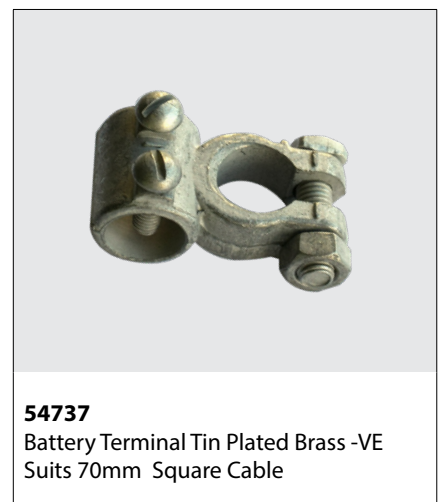
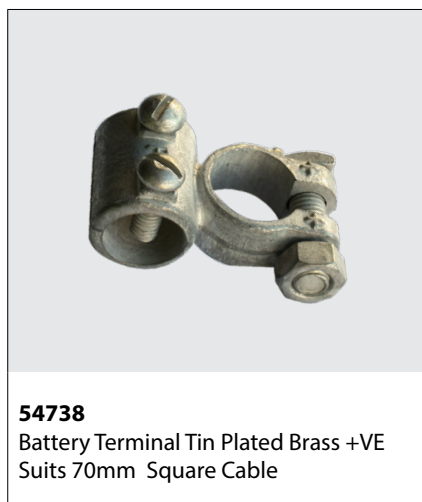

Terminals



40mm ² 50mm ² Cable	
8mm Hole	10mm Hole
53773 Swage On	2811 Swage On
53771 Open End	53770 Open End

60mm ² 70mm ² Cable	
8mm Hole	10mm Hole
53772 Swage On	51010 Swage On
2926 Open End	2927 Open End

53167
Battery Terminal Cut Off With Fuse



53166
Battery Terminal Cut Off

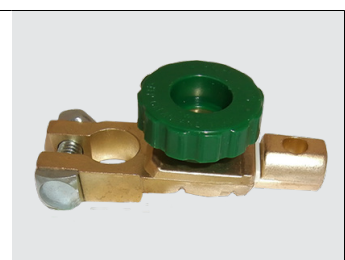

Batteries & Accessories



3875
Heavy Duty Cut Off Isolation Switch
Amp Max Peak Load 12/24V
OE Ref: 1939387



3875E
Heavy Duty Cut Off Isolation Switch
Amp Max Peak Load 12/24V
OE Ref: 1939387



54626
Heavy Duty Cut Off Isolation Switch

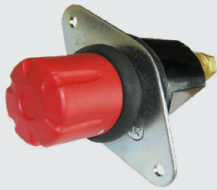

51984
Emergency Cut Off Isolation
Switch Battery



2303
Cut Off Isolation Switch Lucas
Up to 165
OE Ref: A017 - AVBIS004



2923
Cut Off Isolation Switch - Heavy Duty
Max 24V - Max 500A
5 Seconds - Max 100A



53296
Small Angled Rubber Cover Red



53230
Medium Angled Rubber Cover Red



53232
Large Angled Rubber Cover Red



53297
Small Angled Rubber Cover Black



53231
Medium Angled Rubber Cover Black



53233
Large Angled Rubber Cover Black



2647
Left Hand Battery Terminal
Cover Black



2649
Right Hand Battery Terminal
Cover Black



2648
Left Hand Battery Terminal
Cover Red



2650
Right Hand Battery Terminal
Cover Red (+ve)

Relays



51046

Twin Relay



4680

Relay 12v
Normally Open
30A 4 Pin



4681

Relay 12v Normally Open
40A - 4 Pin Starter Relay CX
McCormick



4682

Relay 12v
Changeover
40A - 5 Pin



4692

Relay 12v Changeover 150A - 4 Pin
Normally Open 50HX Starter Relay

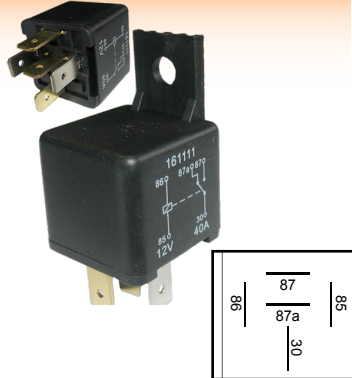

4556

Relay 12v Normally Open 40A



1341

Solenoid Relay 1940 S 390 40 amp
with Loom



530132

Relay 1135 12V 150
Amp Continuous



1106

Relay Flasher Unit
Duncan Cab 21W X 4



51599

Relay 12v Head Lamp
Main Beam & Dim CX MX
Maxxum



4561

Flasher Unit
Electronic

Push Button Switches



51897
Push Button Switch
Plastic with M22
Insulated
Screw Terminals

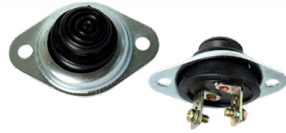

52917
Starter Push Button
Switch 2 Spade
connection
*Diameter 32mm
W: 45mm H: 23.5mm*



51969
Push Button Switch
Waterproof Heavy
Duty M19 Steel
Screw Terminals



51902
Push Button Switch
Brass Fully Insulated
with M22 Insulated
Screw Terminals



51900
Push Button Switch
Fully Insulated
M22 Insulated
Spade Terminals



2098
Starter Push Button
Switch
M22 Plastic
Screw Terminals



51901
Push Button Switch
Fully Insulated with
Screw M22 Insulated
Screw Terminals



2610
Switch Push Button
20amp Heavy Duty
M25 Plastic
Screw Terminals

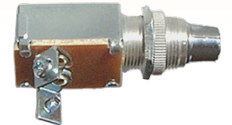

1200
Switch Push Button
Heavy Duty
M15 Steel
Screw Terminals



1483C
Push Button Switch
(Horn) with Rubber Cap
M22 Insulated
Screw Terminals

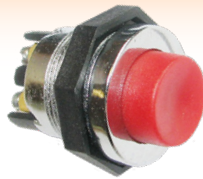

1483
Push Button Switch (Horn)
M22 Steel
Screw Terminals



51968
Switch Push Button Red
M19 Steel
Spade Terminals



51967
Switch Push Button Black
M19 Steel
Spade Terminals

Switches



1323
Ignition Switch Heat
Start Alternator Type 14



1294
Ignition Switch
Dynamo Type -
14mm



6600
Ignition
Switch 600 - 5
Sets of Prongs



51596
Ignition Key Switch 20
TVO TE20, TEA20, TED20



2703
Indicator Switch 135
148 165 188 240 285



62831
Ignition Switch
Massey Ferguson
62 82 54 Series



6758
Ignition Switch 300 4200



1710
Flasher Unit &
Indicator Switch



51529
Switch 3 Pin Pull
to Start



51980
Handle Bar
Switch Quad



1309
Switch Push & Pull
Long Stem



4878
Switch For Fan -
3 Position



3824
Switch - Push/
Pull On/Off



51185
Pull Switch
c/o light



51004
Steering Column
Indicator Switch



51985
Flasher Unit
Adjustable 12V



2703
Indicator Switch 135
148 165 188 240 285
290 50 50B 50H 50HX
Ford 1000



4196
Indicator Switch -
comes with Light Green



54969
Indicator Switch
40W 24V Terminals L R
L54 R54 Red Lens
Black Lever
OE Ref: 0341301005



54970
Indicator Switch
40W 24V Terminals L R
L54 R54 Red Lens
Ivory Lever
OE Ref: 0341301005

55176

Indicator & Lighting Switch Guldner G30
G40G50 G60 Ivory Rod



1839 Lamp Warning Amber Dash Mounted

3101 Lamp Warning Green Dash Mounted

1844 Lamp Warning Blue Dash Mounted

1259 Lamp Warning Red 12v 4W for Alternator

1312 Warning Lamp Red Dash Mounted 12v 1.2W



2613 Light Amber Warning 12v 13mm Hole

1314 Light Red Warning 12v -13mm Hole

2616 Light Warning Green 12v-13mm Hole

2614 Light Blue Warning 12v 13mm Hole



54966

Red Indicator Dash Board Light
Sold in a box of 10

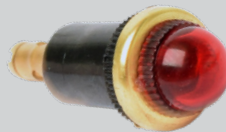

Rocker Switches On/Off Maxi

3512
Plain



Brake Light Switches









51772
Brake Light Switch
Ford 3000 5000
Silver Contact
Super Q Cab
ON when pressed
OE Ref: 81829234









51773
Brake Light
Switch
Off when pressed



HAZARD PUSH BUTTON SWITCHES













Part No.	Compatibility	OE References	Type	
52278	Deutz 07, Agrocompact, Agroprima, Agroxta, DX Series Fendt Farmer, Favorit Lamborghini, Same, Case	89520C91, 01177148, G339900020070, 276591080/10	Push Release	 
53638	Lamborghini, Renault / Claas, Same	7700004827 276591100 6000102320 7704001115	Push Push	 
780224	Renault 100 Series Fendt Farmer, Favorit	7700004827	Push Push	 
52277	Massey Ferguson 2000 3000 600 61 62 81 82 Series Deutz 07 Agroprima, Agroxta, DX Series Fendt	3370427M91 133700580002 01177148	Push Push	 

GENERAL PURPOSE

















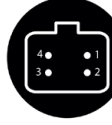

53635	PTO Command	Push Push	 
53641	PTO Command	Push Release	 
53628	PTO Command	Push Push	 
53640	Horn	Push Release	 













PUSH BUTTON SWITCHES SUITABLE FOR MASSEY FERGUSON TRACTORS

Part No.	Function	Models	OE Reference	
64644	PTO Stop	6200 8200	3777568M2	
64645	Lift Raise	6400 7400 8400	3714137M1	
64772	Lift Lower	6400 7400 8400	3714138M1	
64646	PTO Switch	6400 7400 8400	36483900	
64628	Lift Control - Up	44 54 56 57 64 66 67 71 74 76 77 84 Series	4284628M1	
64629	Lift Control - Down	44 54 56 57 64 66 67 71 74 76 77 84 Series	4270312M1	
64640	Speed Shift	2600 2700 3000 3100 3600	3380337M91	
64641	4WD	3100 3600	3385822M1	
64642	PTO 48V 0.5A 10W Normally Open	5400 6400 7400	4270311M1	
64643	Diff Lock	2200 2600 2700 300 3100 3600	3384575M1	
64529	PTO Mudguard 70V 0.5A 10W Normally Closed	54s 64s 74s	4284626M1	
52280	Lift & Lower - Push Release	3000 3600	3388402M1	





PUSH BUTTON SWITCHES SUITABLE FOR CASE TRACTORS

Part No.	Function	Models	OE Reference	
52959	PTO OFF	Case CS100 110 120 130 150 78 86 94 Steyr 9078 9086 9094 9105 9115 9125 9145	140258064	 
52960	PTO ON	Case CS100 110 120 130 150 78 86 94 Steyr 9000 9100	140258046	 
52961	LIFT UP	CS CVX, Steyr 9080M 9090M 9100M 9105 9115 9125 9145 CVT120 130 150 170	140258075	 
52962	LIFT DOWN	CS CVX, Steyr 9080M 9090M 9100M 9105 9115 9125 9145 CVT120 130 150 170	140258076	 
52963	PTO ON	Case CS CVX	140258077	 
52964	PTO OFF	Case CS Steyr 9100Series	140258078	 
52965	PTO ON OFF	Case CS CS Pro CVX Steyr CVT -	140558044	 
52970	REAR LINKAGE	Case CVX Series Steyr CVT Series	140558062	 
52966	CVT LIFT UP	Case CS Pro CVX Steyr 9000 9100 Series	140558046	 
52967	CVT LIFT DOWN	Case CS Pro CVX Steyr 9000 9100 Series CVT	140558045	 



PUSH BUTTON SWITCHES SUITABLE FOR CASE TRACTORS

Part No.	Function	Models	OE Reference	
52968	LIFT UP	Case Cs Cvx Jxc Mxu Quantam Steyr 9000 9100	140558048	 
52969	LIFT DOWN	Case Cs Cvx Jxc Mxu Quantum Steyr 9000 9100	140558047	 
52279	LIFT UP	Case Cs100 Cs110 Cs120 Cs150 Cs48 Cs52 Cs58 Cs63 Cs68 Cs75 Cs78 Cs86 Cs94 Cs48	140258061	 
52945	WORKLAMP	Case C Series Steyr 900 Series	133700580008	 
52280	LIFT & LOWER	Case Maxxum Series	1964848C1	 

HURLIMAN LAMBORGHINI SAME TRACTORS

43119	PTO Control Mudguard Mounted	TM	82016444	 
43741	Rear PTO Control	T6000 T7000 T6 T7 TSA Series	82025543	 

NEW HOLLAND TRACTORS

53633	Front Side Light Switch - Push Push	Hurliman Lamborghini	276591090	 
53637	Engine Stop Switch - Push Push	Hurliman Lamborghini Same	276591130	 
53634	Beacon Switch - Push Push	Hurliman Lamborghini Renault	7700007393	 

PUSH BUTTON SWITCHES SUITABLE FOR DEUTZ TRACTORS

Part No.	Function	Models	OE Reference		
54013	Wiper	Agroprima Agroxta Dx3 Dx4 Dx6 Dx7	01177149		
54016	4 Wheel Drive	Dx 4.10, 4.30, 4.50, 4.70, 6.05, 6.10, 6.30, 6.50, 7.10	01177152		
680085	Pto Command	Agrostar	01144003		
54174	LIFT RAISING AND LOWERING	Agrofarm Agroplus Agrotron 4 6 M Mkiii Proflin Ttv	04412688		
53626	Side Rear Light	Dx Dx4 Dx6 Dx7 S	01177164		
53630	Front Side Light	Agroprima Agroxta Dx Dx3 Dx4 Dx6 Dx7	01177165		
53631	Work Light	Agroprima Agroxta DX DX3 DX4 DX6 DX7	01177162		
54014	Dip Beam	Agroprima Agroxta DX3 DX4 DX6 DX7 Intrac Series	01177876		
54015	Full Beam	Agroprima Agroxta DX3 DX4 DX6 DX7 Intrac Series	01177163		

PUSH BUTTON SWITCHES SUITABLE FOR FENDT TRACTORS

Part No.	Function	Models	OE Reference	
680109	Hydraulic Linkage Lift Lower		671686110030	
680108	Hydraulic Linkage Lift Lower	Farmer 300 Favorit 500 700 800 900	6816860100201	
680107	Light Switch- Interlock Function	Farmer 200 300 Favorit 500 700 800 900	G312900160010	
53631	Work Light		G312900020020	
53632	Rear Side Light		X8302403570000	
680085	Pto Command		G395970100022	
53627	Parking Light	Farmer 200 300 Favorit 600	X830240359000	
53639	Lift & Lower Switch		X830240096000	
53629	Beacon		X830240082000	

Switches



51035
Switch On/Off
Narrow



51042
Switch On/Off/
On 3 Pole

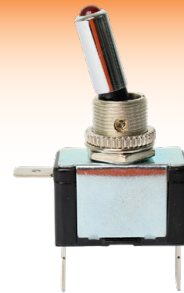

51036
Switch On/Off 3
Pole Red Light



51037
Switch On/On 3
Pole



51038
Switch On/On 6
Pole



51041
Switch On/Off/
On 6 Pole



51039
Switch On/On 4
Pole

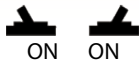

51040
Switch On/Off/
Hold On 3 Pole



53420
Switch Hold On/Off/
Hold On 3 Pole

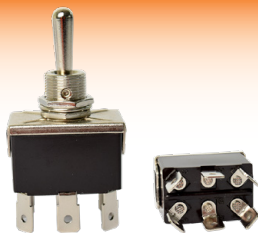

53690
Toggle Switch Hold On/Off/Hold On



51044
Switch Cover



1455
Toggle Switch
On Off 20
Amp



2294
Toggle Switch On/
Off/On 20amp



2618
Switch Toggle On/
Off/On 20 Amp
Heavy Duty

Rocker Switch Panels

3520
Rocker Switch Panel
Single Hole



3521
Rocker Switch
Panel 3 Hole



Fan Cab Blowers

52754

Fan Cab Blower Case XL Maxxum
Maxxum 5120 5130 5140 5150



62780

Fan Cab Blower 3000 6100 5400 6200 8100
Also fits 8200

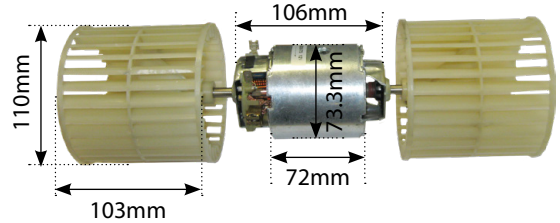

62777

Fan Cab Blower 300



42113

Fan Cab Blower Ford TS T6 T7
Maxxum 100 110 115 120 130 140
MXU MXU 100 110 115 125 130 135



58690

Fan Cab Blower John Deere 40 50 10
SG2 Cab 11 Series Combine SG2 Cab



42111

Cab Blower Ford 40 60 TM TS
Also fits Case JX MXM



44163

Blower Switch Knob
Case IHC MXM Series
OE Ref: 81867238



42214

Blower Resistor Ford
40 60 TM TS
Suits 42111

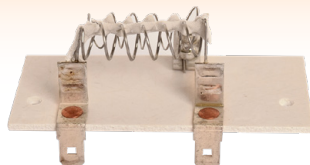

ANALOGUE HOUR METER

2513
12 / 24v Quartz



ANALOGUE HOUR METER

2512
12/24V

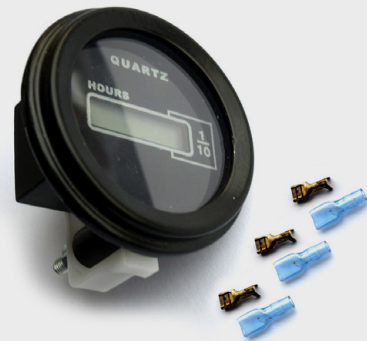

GAUGES



51213
Temperature Gauge with
2.5 mtr Flex



3417
Gauge Water Temperature Electric
Calibrated

USB SOCKET



53785
USB Sockets Dash Mounted

TEMPERATURE SENDERS

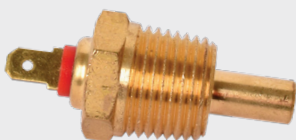

3437
Temperature Sender CASE IH
4210/20/30/40 485, XL/584/685/
695,XL/784/785,XL/885,XL/895,
Thread 1/2" x 14 NPFT



3456
Temperature Sender 5/8" 18
UNI - 42mm

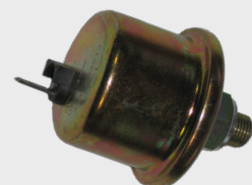

3458
Oil Pressure Sender Unit

CIGAR LIGHTER PLUG



55363
12V



51765
Male Plug For Cigarette Lighter Socket
12V/15A Also for Power Point



QTP New Tractor Paint Range

For a Professional Finish

1. Choose Paint

Spray or Brush from a wide range of colours

2. Use Thinner - TR1488

Mixing Ratio:
Paint : Thinners 9:1 or 10:1

Please note:

Use QTP Thinners Only.
Follow directions on tin.

3. Use Clear Lacquer - TR7000

Tough, Durable & easy to use



Part No.	Description
Massey Ferguson	
TR1187	Paint 1 Ltr Massey Ferguson Red
TR1265	Paint 1 Ltr Massey Ferguson Flint Grey
1200TR	Paint 1 Ltr Gold - <i>Tractol</i>
TR1180	Paint 1 Ltr Ferguson Grey
TR1181	Paint 1 Ltr Silver Mist
TR1399	Paint 1 Ltr Stoneleigh Grey
TR1116	Paint 1 Ltr Tr.Brown / Charcoal Grey
TR1000	Paint 1 Ltr 4200 Chassis Black
TR1004	Paint 1 Ltr 4200 Silver Mist
TR1179	Paint 1 Ltr Smoke Grey
1191TR	Paint 1 Ltr Light Grey - <i>Tractol</i>
Renault	
TR6611	Paint 1 Ltr Renault Orange
TR6615	Paint 1 Ltr Renault Grey
Nuffield	
TR3490	Paint 1 Ltr Nuffield Orange / Red
Zetor	
TR1193	Paint 1 Ltr Zetor Grey
TR1189	Paint 1 Ltr Zetor Chassis Green
TR1183	Paint 1 Ltr Zetor Red

Part No.	Description
Leyland	
TR1190	Paint 1 Ltr Leyland Light Blue
TR1190A	Paint 1 Ltr IHC / Leyland Dark Blue
Landini	
TR1065	Paint 1 Ltr Landini Blue
Komatsu	
TR1192	Paint 1 Ltr Komatsu Yellow
Hitachi	
TR1520	Paint 1 Ltr Old Hitachi Orange
TR1003	Paint 1 Ltr Zaxis Orange
Fendt	
TR1060	Paint 1 Ltr Fendt Green
Fiat	
TR3132	Paint 1 Ltr Fiat Cream
TR3130	Paint 1 Ltr Fiat Brown
TR3131	Paint 1 Ltr Fiat Orange
3487TR	Paint 1Ltr Fiat Opel White
4188TR	Paint 1Ltr Fiat Terracotta Brown
John Deere	
TR2134	Paint 1 Ltr John Deere Yellow
TR1162	Paint 1 Ltr John Deere Green

TR1156 -
Red Oxide Primer



TR2397 -
Buff Primer Undercoat



TR1955 -
Grey Primer Undercoat



Part No.	Description	Part No.	Description
Ford New Holland		Industrial	
TR1071	Paint 1 Ltr Ford Grey	TR1198	Paint 1 Ltr New JCB Yellow
TR3488	Paint 1 Ltr Fordson Orange	TR1185	Paint 1 Ltr Industrial Yellow
TR2440	Paint 1 Ltr Fordson Empire Blue	TR2396	Paint 1 Ltr New CAT Yellow
TR1160	Paint 1 Ltr New Ford Yellow	TR2447	Paint 1 Ltr Kvernland Green
TR1222	Paint 1 Ltr NH Driveline Grey - New Cab	TR1253	Paint 1 Ltr Rotavator Orange
TR1221	Paint 1 Ltr New Holland Grey White for Wheels	TR3684	Paint 1 Ltr Land Rover Blue
TR1194	Paint 1 Ltr New Holland Yellow	TR1195	Paint 1 Ltr Senator Lime Green
TR1196	Paint 1 Ltr New Holland Ford Blue	TR2397	Paint 1 Ltr Buff Undercoat Primer
TR1182	Paint 1 Ltr Ford Tractor Blue	White / Black	
6616TR	Paint 1Ltr New Holland Chassis Grey	TR2175	Paint 1 Ltr Matt Black
Case		TR1109	Paint 1 Ltr Gloss Black
TR4703	Paint 1 Ltr Case/IHC Red	TR1420	Paint 1 Ltr White
TR2393	Paint 1 Ltr Case Brown	TR3710	Paint 1 Ltr Claas White
TR1163	Paint 1 Ltr IHC Off White	Spray Paint	
TR1231	Paint 1 Ltr International Red	53208	Grey Primer Wheel Spray 400ml
TR2401	Paint 1 Ltr Case Tan	53207	Silver Wheel Spray 400ml
David Brown		53210	Matt Black Wheel Spray 500ml
TR1184	Paint 1 Ltr David Brown Orchid	53209	Black High Gloss Wheel Spray 400ml
TR1184A	Paint 1 Ltr Power Red	59633	Aerosol John Deere Green Paint 400ml
TR3489	Paint 1 Ltr David Brown Hunter Pink	59623	Aerosol John Deere Yellow 400ml
Deutz			
TR6618	Paint 1 Ltr Deutz Green <i>Tractor</i>		

Loader Parts

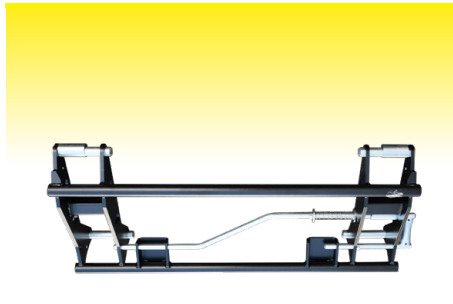

51852
Quick Attach Euro Bracket
Carrier Frame

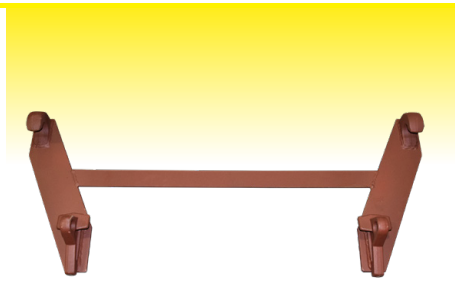

51102
Quick Attach Euro Bracket (Easy Fit)

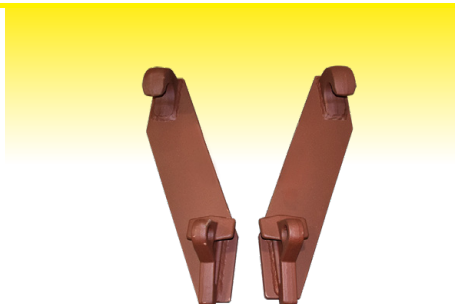

52835
Quick Attach Euro Bracket
Arms Only (Pair)



54569
Loader
Bracket
- Pair



54568
Loader Bracket Hook

54567
Loader Bracket Eye

Kit 51228K
*Made with 1x51228 &
1x51229*



51228
Rear Linkage Quick Hitch
(Tractor Side)



51229
Rear Linkage Quick Hitch Adaptor
Kit no. 51228k

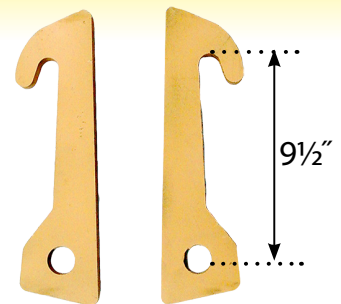

3564
Tanco Loader
Bracket - PAIR

Tines

<p>221194 221192</p>  <p>Tine 26' Curved Tine 32' Curved</p>		
<p>221195</p>  <p>Tine 32' Cranked x 24mm</p>	<p>221193 221151</p> <p>Tine 26' Straight Tine 32" Straight</p>	<p>3726 Nut 20mm to suit Loader Tine</p>
<p>4349 Stonefork Tine 41"</p> 	<p>32SF 241162 241161</p> <p>Stonefork Tine 32" Stonefork Tine 48" Stonefork Tine 980mm with Nut</p> 	<p>3730 Nut 28mm for Stonefork Tine</p> 

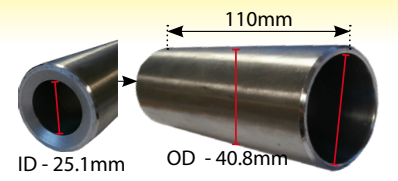

TB1
Bush for Kverneland Tines
110 mm Long 40.8 mm OD
34 + 25.1 mm ID
19.05mm

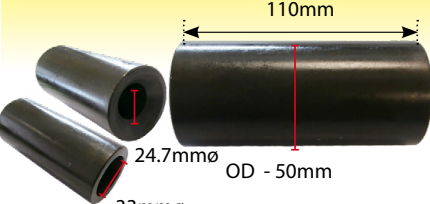

TB1HD
Bush for Kverneland Tines Heavy Duty
110 mm Long OD 50mm
ID 19.05mm

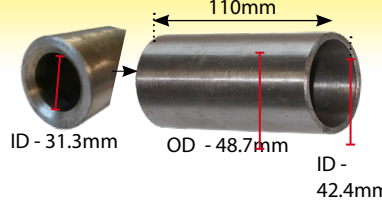

SB1
Bush Tapered Stonefork Tine
110 mm Long 48.7 mm
OD 42.4 + 31.3 mm ID
19.05mm

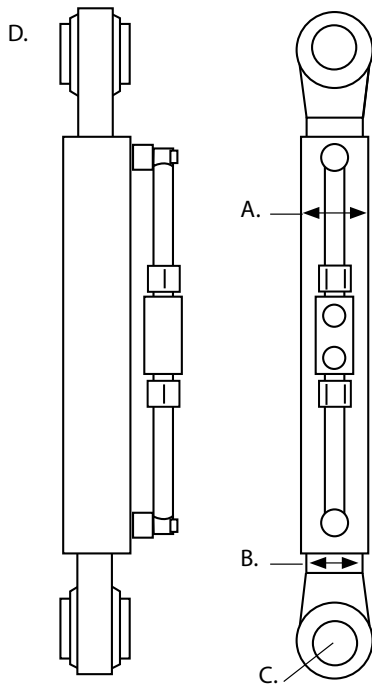

LIGHT DUTY

HYDRAULIC TOP LINKS CAT 2/2

Part No.	Min (mm)	Max (mm)	Stroke (mm)	A. Tube Dia	B. Rod dia	C (mm)	N (mm)	Force (Tonne)
54866	500	675	175	Ø60 x 70	Ø35	Ø26	47	5.6/3.8
54865	550	775	225	Ø60 x 70	Ø35	Ø26	47	5.6/3.8
54864	600	875	275	Ø60 x 70	Ø35	Ø26	47	5.6/3.8
54863	650	975	325	Ø60 x 70	Ø35	Ø26	47	5.6/3.8
54862	700	1075	375	Ø60 x 70	Ø35	Ø26	47	5.6/3.8

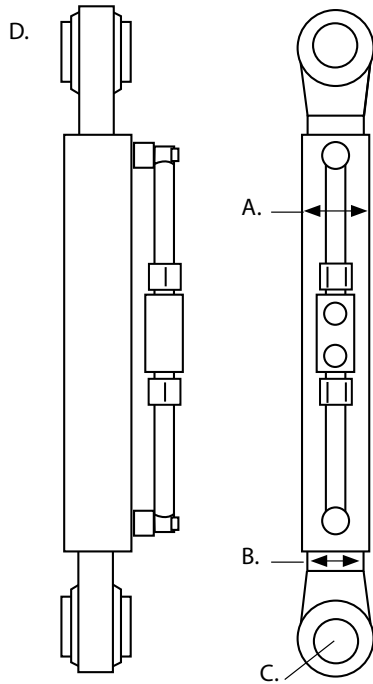

HYDRAULIC TOP LINKS CAT 2/2

HEAVY DUTY

Part No.	Min (mm)	Max (mm)	Stroke (mm)	A. Tube Dia	B. Rod dia	C (mm)	N (mm)	Force (Tonne)
54861	500	707	207	Ø50 x 60	Ø30	Ø26	51	4/2.5
54860	550	807	257	Ø50 x 60	Ø30	Ø26	51	4/2.5
54859	600	907	307	Ø50 x 60	Ø30	Ø26	51	4/2.5
54858	650	1007	357	Ø50 x 60	Ø30	Ø26	51	4/2.5
54857	700	1107	407	Ø50 x 60	Ø30	Ø26	51	4/2.5

Hydraulic Top Links



Complete With Hose & Anti-Creep Valve

53458

Min Length	470mm	Cylinder ID	50mm
Max Length	680mm	Piston Rod Diameter	30mm
Ram Stroke	210mm		



Complete With Hose & Anti-Creep Valve

53459

Min Length	540mm	Cylinder ID	50mm
Max Length	820mm	Piston Rod Diameter	30mm
Ram Stroke	280mm		



Complete With Hose & Anti-Creep Valve

53460

Min Length	430mm	Cylinder ID	50mm
Max Length	590mm	Piston Rod Diameter	30mm
Ram Stroke	160mm		



Complete With Hose & Anti-Creep Valve

53461

Min Length	480mm	Cylinder ID	50mm
Max Length	690mm	Piston Rod Diameter	30mm
Ram Stroke	210mm		



Complete With Hose & Anti-Creep Valve

53462

Min Length	570mm	Cylinder ID	63mm
Max Length	886mm	Piston Rod Diameter	35mm
Ram Stroke	296mm		



Complete With Hose

53463

Min Length	620mm	Cylinder ID	63mm
Max Length	931mm	Piston Rod Diameter	35mm
Ram Stroke	311mm		

Hydraulic Top Links

**Cat 2 Hook
- Cat 2 Ball**



**Complete With Hose,
Anti-Creep Valve
& Transport Handle**

53464

Min Length	585mm
Max Length	859mm
Ram Stroke	274mm
Cylinder ID	63mm
Piston Rod Diameter	35mm



**Complete With Hose,
Anti-Creep Valve
& Transport Handle**

53465

Min Length	595mm
Max Length	834mm
Ram Stroke	239mm
Cylinder ID	80mm
Piston Rod Diameter	40mm

**Cat 2 Hook
- Knuckle**



**Complete With Hose,
Anti-Creep Valve
& Transport Handle**
KNUCKLES NOT INCLUDED

53453

Min Length	580mm	640mm Including Knuckle
Max Length	825mm	885mm Including Knuckle
Ram Stroke	245mm	
Cylinder ID	80mm	
Piston Rod Diameter	40mm	

**Knuckle
Options**



53467 Cat 2
25mm
Pin & R Clip included



53468 28mm
28mm
Pin & R Clip included

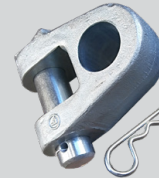

53469 Cat 3
32mm
Pin & R Clip included

Hydraulic Top Links

Cat 3 Ball - Knuckle

Complete With Hose, Anti-Creep Valve & Transport Handle
KNUCKLES NOT INCLUDED

53452

Min Length	580mm	640mm Including Knuckle
Max Length	825mm	885mm Including Knuckle
Ram Stroke	245mm	
Cylinder ID	90mm	
Piston Rod Diameter	45mm	

Cat 3 Hook - Knuckle

Complete With Hose, Anti-Creep Valve & Transport Handle
KNUCKLES NOT INCLUDED

53455

Min Length	505mm	565mm Including Knuckle
Max Length	646mm	706mm Including Knuckle
Ram Stroke	141mm	
Cylinder ID	90mm	
Piston Rod Diameter	40mm	

Knuckle Options



53467 Cat 2
25mm
Pin & R Clip included

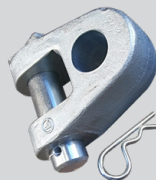

53468 28mm
28mm
Pin & R Clip included



53469 Cat 3
32mm
Pin & R Clip included

Complete With Hose, Anti-Creep Valve & Transport Handle
KNUCKLES NOT INCLUDED

53456

Min Length	590mm	650mm Including Knuckle
Max Length	816mm	876mm Including Knuckle
Ram Stroke	226mm	
Cylinder ID	90mm	
Piston Rod Diameter	45mm	

Complete With Hose, Anti-Creep Valve & Transport Handle
KNUCKLES NOT INCLUDED

53457

Min Length	620mm	680mm Including Knuckle
Max Length	835mm	895mm Including Knuckle
Ram Stroke	215mm	
Cylinder ID	105mm	
Piston Rod Diameter	45mm	

53473
Hose Hydraulic Top Link
800mm Pair
c/o Fittings



Knuckle Options

Cat 2



53467
25mm CAT2
Pin & R Clip

Cat 28mm



53468
28mm
Pin & R Clip
Suits Ford 40s TSs

Cat 3



53469
32mm CAT3
Pin & R Clip



53466
Pin & R Clip

Handles

43142
Handle - New Holland

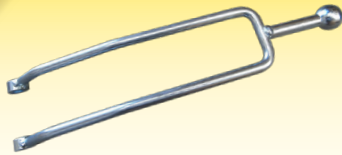

53471
Handle -
Long 10mm / 350mm

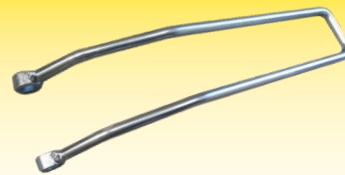

59028
Handle - John Deere



53470
Handle
Short 10mm / 275mm



53472
Handle Clip



Balls

4044

Cat 2



21018

Cat 2/3

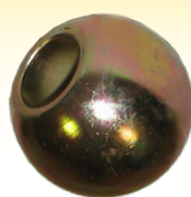











21019

Cat 3/3



41746
Chain For Quick
Release CBM Type

Standard Top Links









Part No	Applications		Min	Max
62108	Top Link 16" Cat 1 & 2 <i>Ratchet Handle is 51770</i>		520mm	700mm
1547	Top Link Cat 1 & 2 <i>Ratchet Handle is 51770</i>		613mm	770mm
2474	Top Link David Brown Cat 2 Cat 1, Conversion Tube 14 1/2" Adj Min 20" Max 30"		490mm	725mm
3792	Top Link Cat 2 Heavy Duty Tube 19" Adj Min 24 7/16" Max 35 5/16"		615mm	855mm
53403	Top Link Cat 2 OE Ref: 3808658M91		720mm	920mm
3785	Top Link 16" Heavy Duty Cat 2		560mm	800mm
3676	Top Link Cat 3 H/D 19" Jumbo Tube 19" Adj Min 25 5/16" Max 35 7/16" <i>Cat 3 to Cat 2 Conversion Bush is 53475</i>		650mm	880mm
51770	Handle for Ratch on Top Link fits 62108 1689 1690 1547 51720 <i>Shaft size is 44mm</i>			
1689	Top Link 20" Cat 2 Tube 20" <i>Ratchet Handle is 51770</i>		625mm	915mm
1690	Top Link 16" Cat 1 Tube 16" <i>Ratchet Handle is 51770</i>		520mm	700mm

Standard Top Links

Part No	Applications		Min	Max
21008	Top Link Assembly Cat 2 - Standard Duty Tube 7" <i>Screw On End For Right Hand Thread is 21022</i>		315mm	410mm
21011	Top Link Assembly - Standard Duty Tube 7 1/2"		280mm	360mm
21010	Top Link Assembly Cat 2 Tube 11 1/4"		405mm	585mm







Massey Ferguson Standard Top Links





Part No	Applications		Min	Max
61612	Top Link 135 148 Cat 1/2 <i>Use with 35" Lift Arm - 1869289</i> OE Ref: 194376M91		640mm	770mm
1164	Top Link 165 188 21.5" Cat 2 + 2 OE Ref: 1887285M91		710mm	838mm
1165	Top Link 188 590 595 21" Cat 2 OE Ref: 1660050M91		675mm	855mm
41738	Top Link CBM Cat 2 (15" Tube) Min 23" Max 31" Landini Legend/Mc Cormack MC & MTX's		570mm	780mm
2525	Top Link Quick Release Cat 2/2 3000 3100 6100's OE Ref: 3615052M4		645mm	736mm
63459	Top Link 35 135 148 Cat 1/2 OE Ref: 1870075M91		685mm	838mm
61609	Top Link Assembly FE 35 135 Cat 1/1 <i>Use with 32" Lift Arm 182632</i> OE Ref: 184134M91		590mm	750mm
61610	Top Link Assembly FE 35 135 Cat 1/2 <i>Use with 32" Lift Arm 182632</i> OE Ref: 184134M91		600mm	750mm
61611	Top Link 135 148 Cat 1/1 <i>Use with 35" Lift Arm - 1869289</i> OE Ref: 184078M91		630mm	770mm

OE Style Top Links

John Deere

Part No	Applications		Min	Max
59768	Top Link John Deere 6000 CAT II/III 38mm (61cm) long (Centre to Centre)		610mm	
59287	Top Link John Deere 6000 CAT II/II 605mm Centre to Centre <i>59771 is Budget Version</i>		605mm	
59771	Top Link John Deere 6000 CAT II/II 38mm		635mm	
2458	Top Link John Deere Cat 1 & 2 Heavy Duty Adj Min 550mm Max 760mm		550mm	760mm
3252	Top Link Assembly John Deere 13" Cat 1 & 2		610mm	762mm

Ford

Part No	Applications		Min	Max
3027	Top Link Ford 5600 7600 17" Cat 2		630mm	794mm
3028	Top Link Ford 4000 4600 16.75" Cat 1 + 2		610mm	795mm
41309	Top Link Ford 40 - CAT 2 Ball 28mm Eye Fiat M100 to M160 - Knuckle is 53469		630mm	850mm
42066	Top Link Assembly TM TS Cat 3 Hook		620mm	896mm

Heavy Duty Top Links

Part No	Applications		Min	Max
4115	Top Link John Deere/Fendt CAT 2 SuperLink Tube 19"		610mm	
3251	Top Link CAT 3 Superlink Tube 19" <i>Cat 3 to Cat 2 Conversion Bush - 53475</i>		660mm	
2199	Top Link John Deere Cat 2 SuperLink Tube 15"		550mm	
3234	Top Link CAT 3 Superlink Tube 15" <i>Cat 3 to Cat 2 Conversion Bush - 53475</i>		570mm	

Knuckle Ends

3207	Quick Hitch Hook Cat 3/3 & Ball End Top Link Tube 19"		680mm	
21003	Quick Hitch Hook CAT 2/3 & Ball End Top Link Tube 15"		595mm	
21004	Top Link Cat 3 Ball End & Knuckle End Tube 15" 25mm B <i>Top Link End is 21016 Cat 3 to Cat 2 Conversion Bush - 53475</i>		550mm	
21005	Top Link Cat 3 Ball End & Knuckle End Tube 15" 28mm B <i>Cat 3 to Cat 2 Conversion Bush - 53475</i>		454mm	
21006	Top Link Cat 2 Ball End & Knuckle End Tube 15" 25mm B		570mm	
21007	Quick Hitch Hook CAT 2 & Knuckle End Top Link Tube 15" 25mm bore		660mm	
21014	Top Link John D Cat 2 3 Ball End &Knuckle End Tube 15" 32mm B		570mm	

Top Link Components

Accessories

61293

Top Link
Securing Hook

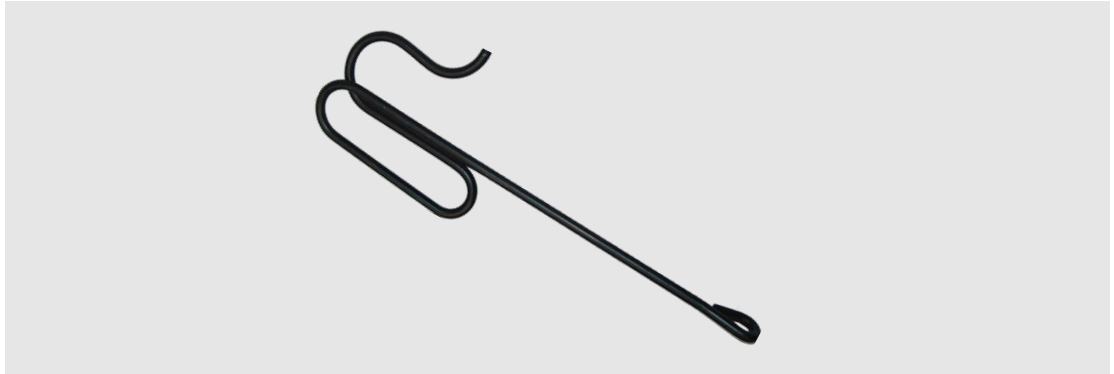

Top Link Pins

195589 Top Link Pin Cat 1 Working Length: 102mm

195590 Top Link Pin Cat 1 Working Length: 110mm

1461 Top Link Pin Cat 1 4.75" Working Length: 127m

2363 Top Link Pin 188 CAT 2 4 5/16" Working 110mm

53029 Top Link Pin Cat 1

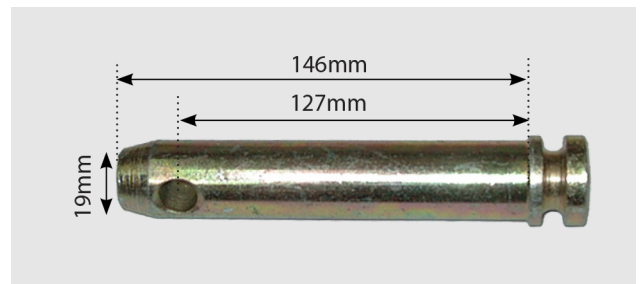

Lower Link Implement Pin

62795 Lower Link Pin Cat 1 Mounting Pin

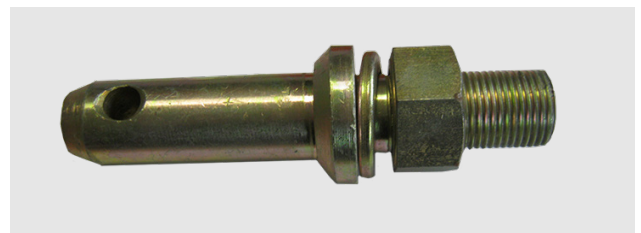

Lower Links

4418 **Cat 2**



Link Ball Lower c/o Guide Cone Cat 2
Pin To Suit is 4419

4727 **Cat 3/3**



Link Ball Cat 3/3 & Guide Cone
Pin To Suit is 4419

4729 **Cat 2/3**



Link Ball Cat 2/3 & Guide Cone
Pin To Suit is 4419

4419



Linch Pin for 4418
12mm Diameter Pin

Lower Link Balls

2539 **Cat 3/2**

Lower Link Ball Cat 3/2
ID 29mm
OD 63.5mm

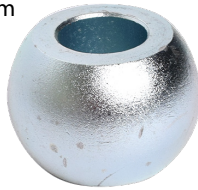

2540 **Cat 3/3**

Lower Link Ball Cat 3/3
ID 37.5mm
OD 63.5mm



62228 **Cat 2/2**

Ball Cat 2/2 For Lower Quick Release End



1869219



Lift Arm Ball Clip

886428 **Cat 1**

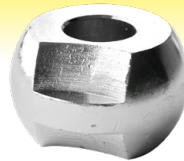

Lower Link Ball Cat 1 Interchangeable
Fits 100 200 300 4200 4300 600 Series

886429 **Cat 2**

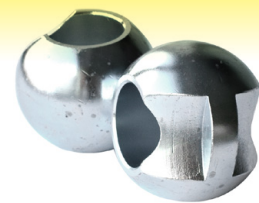

Lower Link Ball Cat 2 Interchangeable
Fits 100 200 300 4200 4300 500 600 Series

Lower Link Conversion Bushes

43155 **Cat 2 to Cat 3**



Bush Lower Link Conversion
Cat 2 to Cat 3

53496 **Cat 2 to Cat 3**



Bush Lower Link Conversion Cat 2 to Cat 3
ID 1 1/8" OD 1 7/16" Length 2 1/2" 63.5mm

2424 **Cat 1 to Cat 2**



Lower Link Conversion Bush
1 1/8' to 7/8'

Top Link Balls

21018

Top Link Ball

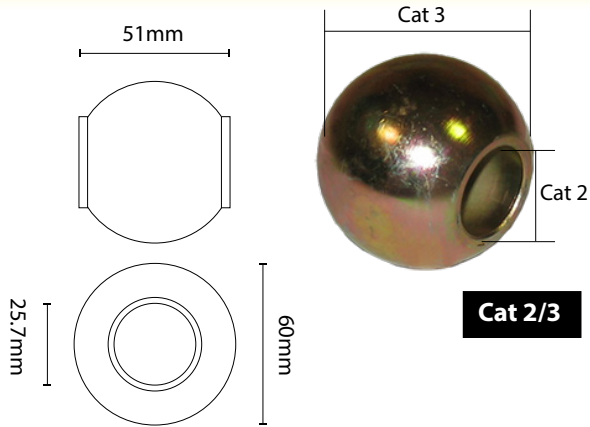

21019

Top Link Ball

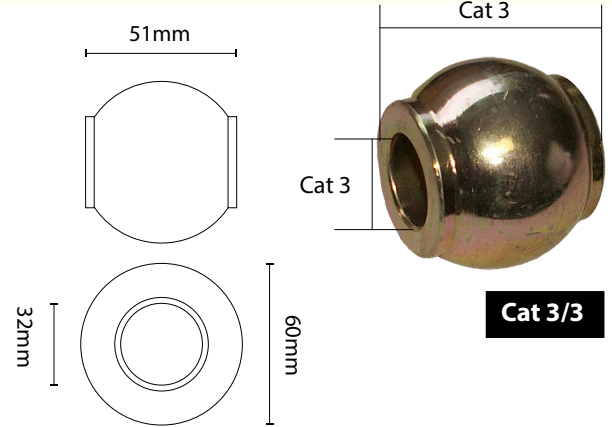

4044

Top Link Ball

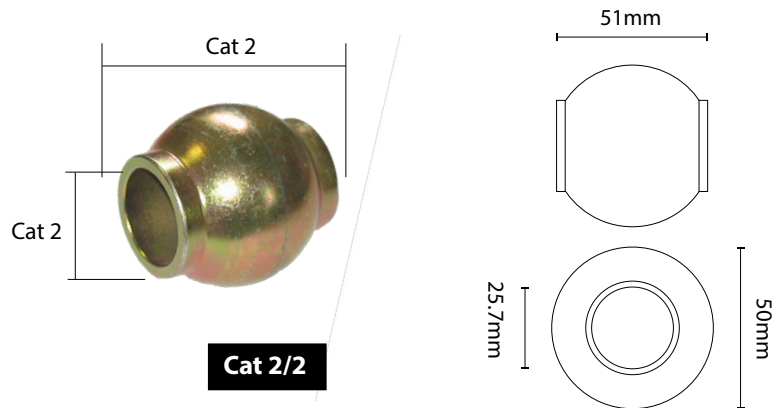

Top Link Conversion Bushes

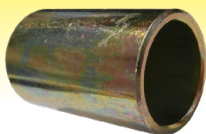

53475

Bush Top Link Conversion Cat 2 Cat 3

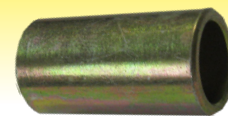

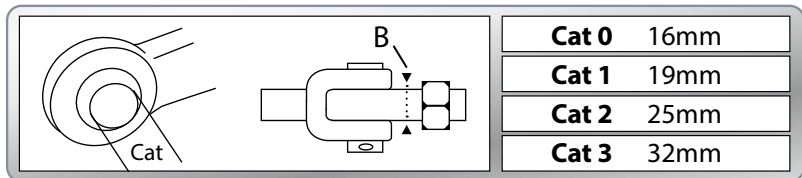

42144

Top Link Conversion Bush Ford 10 100 Cat 1/2
1000 30 40 Industrial TW Series



Cat 0	16mm
Cat 1	19mm
Cat 2	25mm
Cat 3	32mm

CAT 1		Part	Applications	Cat	Min	Max	B
	410mm	61495	Stabiliser 290 Telescopic 61511 & 61510 - Stabiliser Brackets	1	410	570	20
	450mm	61496	Stabiliser 265 Telescopic OE Ref: 0013961	1	410	570	20
	590mm	61214	Stabiliser Assembly 4200 4300 OE Ref: 3820759M91	1	590	860	25
		64940	42 Series 43 Series Original Type From Serial Number J21149 OE Ref: 3819481M91	1	605	880	25
CAT 2		Part	Applications	Cat	Min	Max	B
		62955	Stabiliser 5400 6200 6400 8200 OE Ref: 3794474M91	2	407	502	24
		62955R	Stabiliser Massey Ferguson 5400 6200 6400 8200	2	407	502	24
	450mm	62139	Stabiliser 3 31 36 61 62 81 8200's Heavy Duty	2	450	640	25
	500mm	62813	Stabiliser 5425 5435 5445 5455 5460 5465 OE Ref: 3798069M91	2	500	640	27

AUTOMATIC STABILISERS		Part No.	Application	Cat	Min	Max	B
		65100	Automatic Stabiliser 54 64 66 74 76 82 84 Series OE Ref: 4271701M91	2	600	650	25.5
		65133	Stabiliser Automatic Massey Ferguson 54 64 66 74 76 82 84 Series OE Ref: 100219004	2	510	560	25.5

Vintage Stabilisers

	2805	Adjustable Stabiliser Short <i>Min 376mm Max 471mm</i> Massey Ferguson 35 Early 135 Ferguson 20
	3610	Levelling Fork to Lift Arm Implement Pin TE20 Also 35 135 148 <i>Working Length: 7/16" Thread Length: 1"</i>
	64610	Load Sensor Pin 40KN 3050 - 3095 54s 61s 62s OE Ref: 3713763M2
	894208	Stabiliser Bar 65 165 Adjustable <i>Min 723mm Max 914mm 23mm Hole</i>

Stabiliser Bars

	562620	Stabiliser Bar 3 Hole Spring Steel Flat
	1691	Stabiliser Bar 2 Hole Flat
	63282	Stabiliser Bars & Brackets Kit 35 135

Chain Stabilisers & Check Chains

	2041	Check Chain 35 135
	62128	Chain Stabiliser 135 - 2 Links
	2225	Chain Stabiliser 135 Heavy Duty
	1863260	Chain Stabiliser 135 240 Chain OE Type
	1861968	Check Chain 148 240
	893410	Check Chain 265 285 - 5 Link <i>62 x 12.5mm</i>
	2522963	Chain Stabiliser 188 165 390 590
	2522963BRACKET	Chain Stabiliser Bracket 188 165 390 590
	2044	Chain Stabiliser - All Models <i>Min 819mm Max 927mm</i>

Stabiliser Brackets



1395
Stabiliser Bracket 35 135
Left Hand
1394 is Right Hand
OE Ref: 81801293

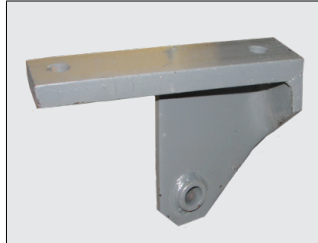

62621
Stabiliser Bracket 165 168 175
178 185 188 Left Hand
62620 is Right Hand
OE Ref: 1860625M91



61511
Stabiliser Bracket Square Axle
Left Hand
61510 is Right Hand
OE Ref: 888662M94

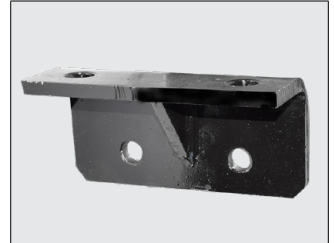

2818
Stabiliser Bracket 135/240
Right Hand & Left Hand
OE Ref: 1865256M91



897678
Eye Bolt Assembly 20D 35
4 Cylinder
897677 is for 35 35X 133 135 140 45mm



61601
Check Chain Mounting
Bracket (Pair)



1824
D Shackle Clevis Assembly

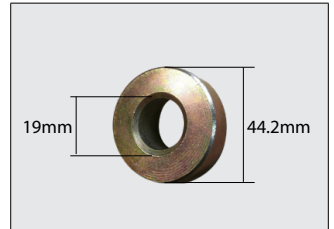

1865159
Stabiliser Spacer 165 300
Also 200 500 600 Series

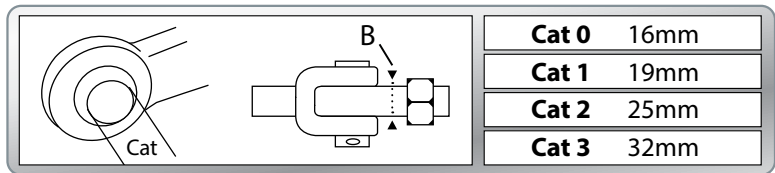

Cat 0	16mm
Cat 1	19mm
Cat 2	25mm
Cat 3	32mm

CAT 1

Part	Applications	Cat	Min	Max	B
<p>395mm</p> <p>18mm</p>	<p>59894 Stabiliser John Deere 6010-6920</p>	1	395	450	18
<p>450mm</p>	<p>59920 Stabiliser John Deere 6000's</p>	1	450	510	18
<p>480mm</p>	<p>59654 Stabiliser John Deere 6000's H Duty Short <i>59650 - Stabiliser Bracket</i></p>	1	480	700	25
<p>530mm</p>	<p>59653 Stabiliser John Deere 6000's H Duty Long <i>End is 51975</i></p>	1	530	760	25

CAT 2

Part	Applications	Cat	Min	Max	B	Float
<p>448mm</p> <p>CBM SpA COSTRUZIONI MECCANICHE</p>	<p>59089 Stabiliser John Deere Automatic 6010 6110 6210 6310 6410 6510 6610 6810 6910 7600 7700 7800 7430PR</p>	2	448	467	24	+ - 36
	<p>58252 Stabiliser Automatic John Deere 8235R 8245R 8260R 8270R 8310R 8320R OE Ref: RE559338</p>	2	425	445	25	

Chain Stabiliser

	<p>51099</p>	<p>Chain Stabiliser Assembly John Deere 2040 3640</p>
---	---------------------	---

51975
Stabiliser End John Deere
6000 H Duty Long
Length: 122mm, Dia: 24mm

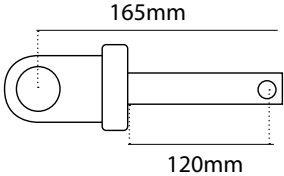

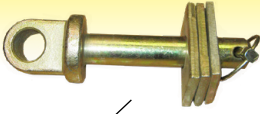

59653
Stabiliser John Deere
6000's H Duty Long



Brackets



6 Cylinder

59650
Stabiliser Bracket John Deere
6800 6900 6810 6910 6820 6920
6920s 6830 6930 Not For 6600 or
any 4 Cylinder Models



4 Cylinder

58960
Bracket Stabiliser 6100 6200 6300
6300 6400 6506 6600 6010 6110
6210 6310 6410 6510 6610 6810
6910 6910S 6020 6120 6220 6320
[OE Ref: L155798](#)

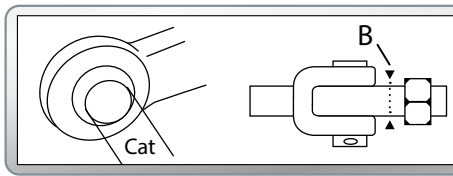

Cat 0	16mm
Cat 1	19mm
Cat 2	25mm
Cat 3	32mm

	Part	Applications	Cat	Min	Max	Float	B
 <p>380mm</p>	42258	T6030 T6050 TS115A TS130A T6040 TS110A T6010 T6070 TS100A T6060 Stabiliser Pin -42259 Bracket - 43505	1	380	560		20
 <p>430mm</p>	41763	TM & 60s Heavy Duty OE Ref: 5170360	1	430	630		25
 <p>430mm</p>	41763R	TM & 60s Normal Duty End is 51978		430	630		25
 <p>430mm</p>	43037	TM115 TM125 TM135 TM150 TM165 Automatic	1	430	490	40	26
 <p>461mm</p>	59090	Automatic TM175 TM190T7030 T7040 T7050 T7060	2	461	482		36
	59090R	Stabiliser Automatic Ford New Holland TM175 TM190 T7030 - T7060 John Deere 8000 - 8310	2	460	490		25
 <p>460mm</p>	4964	Ford 4000	1	460	650	40	18

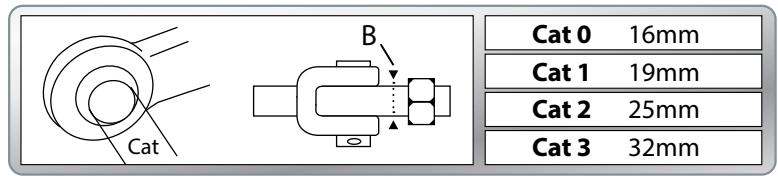

	Part	Applications	Cat	Min	Max	Float	B
 <p>480mm</p>	12000	Ford 40 TS 8210 Replacement (A ' B ¾') (NORMAL DUTY)	1	470	620		20
 <p>500mm</p>	42257	Ford TS100 TS110 TS115 TS80 TS90 Also fits TV140	1	500	740		20
 <p>500mm</p>	41802	5000 - 8210 Heavy Duty End - 51973	1	500	720		18
 <p>520mm</p>	409710	Ford 40 Series Heavy Duty End is 51973	1	520	730		20
 <p>540mm</p>	4963	5000	1	540	770	40	18
 <p>430mm</p>	43244	Stabiliser Ford 2000 3000 3600	1	430	600		
 <p>380mm</p>	43537	T4000s TNs	1	380			



FORD & NEW HOLLAND

Chain Stabilisers & Components

Chain Stabilisers

	1951	Stabiliser Power Major
	3026R	Stabiliser Ford 4000 4600 4610
	3025R	Stabiliser Ford 5000 5600 6600 7000 7600
	41821	Chain Stabiliser Ford 4000 4600 4610 4630 And 5000 5030 5600 6600 7000 7600

1168
Chain Stabiliser Tube Ford + Weight

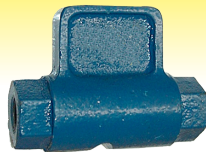

43345

Anchor Bracket Check Chain Ford 2000 4000 600 800 900 601 701 801 901 Dexta Super Dexta 2N 8N 9N Jubilee NAA Left Hand

OE Ref: 957E596

43344

Anchor Bracket Check Chain Ford 2000 4000 6008N 9N Jubilee NAA Right Hand

OE Ref: 957E597



Stabilisers Hangers

41359
Stabiliser Hanger
Ford 2910/3910 Left
Hand



41360
Stabiliser Hanger Ford
2910/3910 Right Hand

41364
Stabiliser Hanger Ford
6610 7610 Left Hand

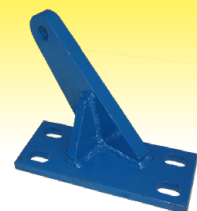

41361
Stabiliser Hanger Ford
6610 7610 Right Hand

FORD & NEW HOLLAND

Stabiliser Components

52193

Clevis for 41802 Ford 5000 -
8210 Stabiliser Heavy Duty

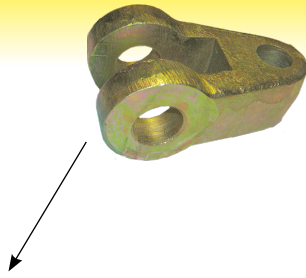

51973

Stabiliser End Threaded Ford
40 Series H Duty

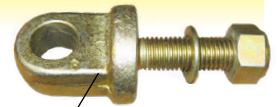
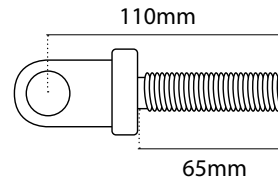

41802

Stabiliser for Ford 5000 -
8210 Heavy Duty



409710

Stabiliser Ford 40
Series Heavy Duty



51978

Stabiliser End TM & 60 Series H
Duty Length: Dia: 25mm

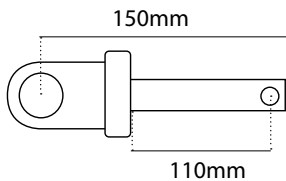

42259

Pin Stabiliser Ford T6030 T6050 TS115A
TS130A T6040 TS110A T6010 T6070
TS100A T6060



43505

Stabiliser Bracket Ford T60s TSAs



41763

Stabiliser TM & 60s
Heavy Duty



42258

Stabiliser Ford T6030 T6050
TS115A TS130A T6040 TS110A
T6010 T6070 TS100A T6060



U Bolts

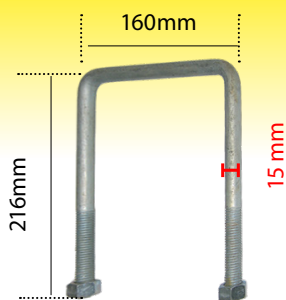

41366

6610/7610 Stabiliser
Bracket U Bolt

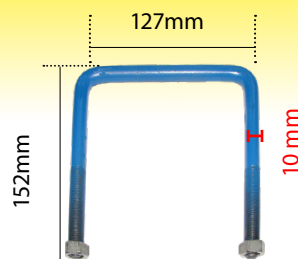

41581

U Type Bolt Ford
3000 Mudguard

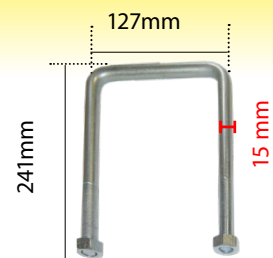

41512

U Bolt For Stabiliser
Fixing Bar Ford 2910/
3910/4110/4620

Stabilisers

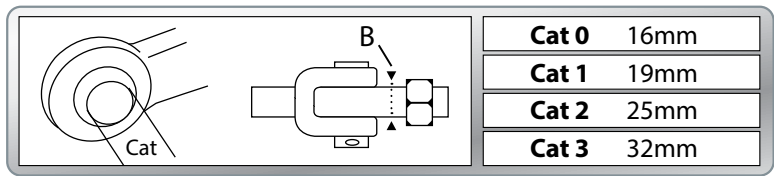



Cat 0	16mm
Cat 1	19mm
Cat 2	25mm
Cat 3	32mm

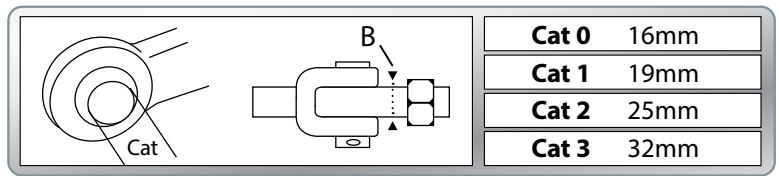

CASE	Part	Applications	Cat	Min	Max	B
 320mm	59652	McCormick Case CX H Duty	1	320	450	22
	59651	McCormick Case MX H Duty	1	520	720	22
 411mm	52458	Case 5120 5130 5140 5150 5220 5230 5240 5250 MX100 MX100C MX120 MX135 MX80C MX90X OE Ref: 112923A1	1	411	670	24
  390mm	52460	Case 640 644 740 743 744 745 745S 840 844 844S 845 856 940 946 955 956 1046 1056 OE Ref:1965995C91	1	390	640	
	1635	IHC ALL MODELS 385 454 474 475 484 485 485 XL 574 584 585 585 XL 674 684 685 685 XL 784 OE Ref: 3620019R1				
 430mm	41763	MXM120, MXM130, MXM140, MXM155, Heavy Duty OE Ref: 5170360	1	430	630	25
 430mm	41763R	MXM120, MXM130, MXM140, MXM155, Normal Duty End is 51978		430	630	25
	43771 Left Hand	Case Quantum 75F - 105F New Holland T4000 T4 OE Ref: 5197056 - LH				
 	55289	Automatic Stabiliser Maxxum MX80C - MX135 5120 - 5150 Maxxum OE Ref: 253697A2	1	375	410	19
 	52436	Stabiliser Case JX80 JX90 JX95 Ford TD80D TD90D Plus TD95D Plus OE Ref: 5189644	1	400	540	19
 	43536	Stabiliser New Holland T7s TM175 TM190 Case MXM Puma OE Ref: 5197252	2	420	540	25.7

Stabilisers



Cat 0	16mm
Cat 1	19mm
Cat 2	25mm
Cat 3	32mm

CASE	Part	Applications	Cat	Min	Max	B
	55379	Stabiliser Case MX80 - MX135 OE Ref: 310208A2	1	445	595	19.3
	55518	Stabiliser Case IH 3000 4000 C CX Series OE Ref: 119307A3	1	330	400	19

DAVID BROWN	Part	Applications	Cat	Min	Max	B
	2171	Stabiliser Assembly David Brown 4 Cylinder 990 995 996 1210 1212 1290 1294 1390 1394 1410 1412 1490 1494	1	635	750	20
 470mm	2204	Stabiliser David Brown 1690 1594 1694	2	470	780	20

RENAULT	Part	Applications	Cat	Min	Max	B
 585mm	780061	Stabiliser Renault Ceres MS - MX	2	585	835	24

Stabilisers

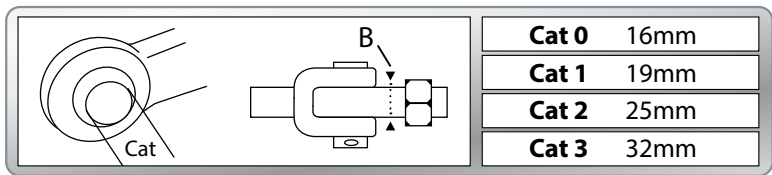

Cat 0	16mm
Cat 1	19mm
Cat 2	25mm
Cat 3	32mm

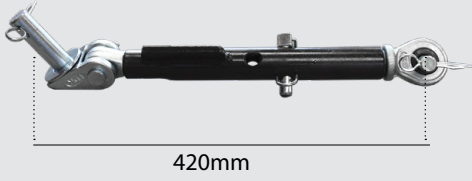
FIAT	Part	Applications	Cat	Min	Max	B
	4063	Stabiliser Fiat 100-90 420mm Long	1	420	530	25

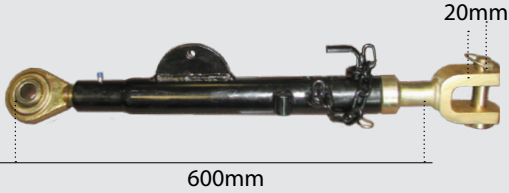
ZETOR	Part	Applications	Cat	Min	Max	B
	59649	Stabiliser Zetor Forterra Heavy Duty	1	600	840	20

LANDINI	Part	Applications	Cat	Min	Max	B
	59519	Stabiliser Landini Ghibli 90 530mm long End = 51974	1	530	750	25

VALTRA	Part	Applications	Cat	Min	Max	B
	52867	Stabiliser Valtra Valmet T Series	2	490	720 Float is 45	20

Stabilisers Normal Duty

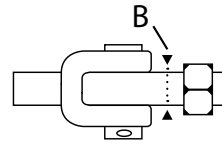
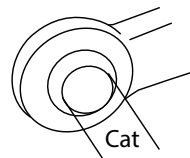

Cat 0	16mm
Cat 1	19mm
Cat 2	25mm
Cat 3	32mm

MISCELLANEOUS Cat 1

Part No	End to Suit	Cat	Min	Max	Float	B
 440mm		1	440	600	50	25
 470mm	End = 51973 	1	470	620		20
 510mm		1	510	670	50	25

MISCELLANEOUS Cat 2

Part No	Description	Cat	Min	Max	Float	B
 440mm		2	440	600	50	25
 510mm		2	510	670	50	25

MISCELLANEOUS Cat 2 HEAVY DUTY

 440mm	Stabiliser Rigid 3000 Min 440 Max 600	2	440	600	50	25
--	--	---	-----	-----	----	----

Stabiliser Pins

- 51739** Shaft Locking Pin 8mm x 57mm
- 51740** Shaft Locking Pin 6mm x 50mm
- 51741** Shaft Locking Pin 11mm x 89mm
- 51742** Shaft Locking Pin 9.5mm x 57mm
- 7387** Stabiliser Pin Fiat 100-90 Ford 40 16mm Thick
- 53060** Linch Pin Stabiliser 59mm x 10mm



Linkage Components

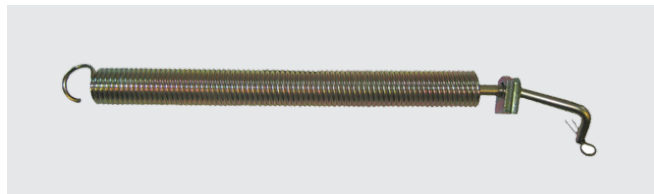

4035
Lift Arm Spring Ford 5000 7200 Lower
Adjustable Spring Spacer (500 - 720mm Adj)



7819
Spring Lower Link Restrainer Ford F140
7030 7070 TM115 TM190 Fiat 55-46 65-66
60-90 80-90 90-90 100-90 110-90 180-90

Clevis End

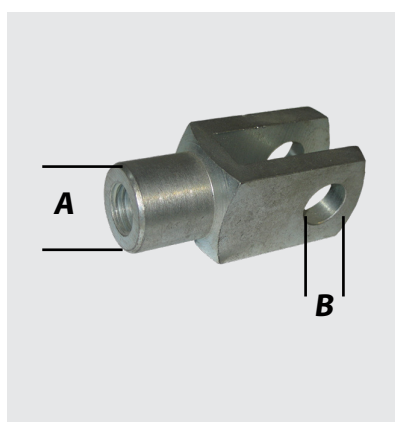

Part No	Size A mm	Size B mm	Photo
12330	6	12	
12331	8	16	
12332	10	20	
12333	12	24	
12334	14	27	

Part No	Size A mm	Size B mm	Photo
12335	16	32	
12385	18	36	
12386	20	40	

Clevis End Pins

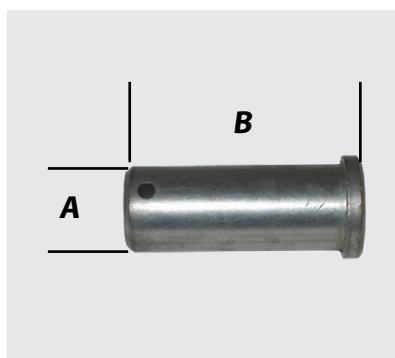

Part No	Size A mm	Size B mm	Photo
12336	6	16	
12337	8	20	
12338	10	25	
12339	12	30	
12340	14	36	
12341	16	42	

Clevis End Safety Pins

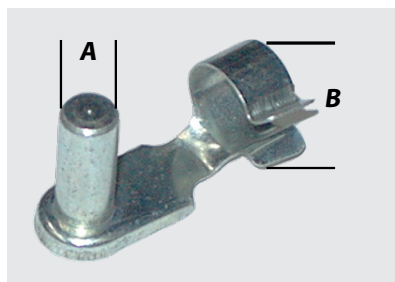

Part No	Size A mm	Size B mm
12390	20	44

Linkage Components

Clips



52896
Suits 8mm Pin
Spring Clip



6988
Suits 7mm Pin
Speed Clip 200 300 600
4200 4300



1861511
Suits 6mm Pin
Control Valve Lever
Ret Clip



7207
Suits 4mm Pin
Throttle Cable Clip Fiat

Ball Ends



- 4039** Ball End 5 x 1
- 4040** Ball End 6 x 1
- 4041** Ball End 8 x 1.25
- 4042** Ball End 10 x 1.5

Split Pins



- 1354** Split Pin 1/16" x 2"
- A1509** Split Pin 8mm x 63mm

3.2x50	3.9x63	4.7x75	6.3x50	6.3x25	7.9x63
50pcs	30pcs	20pcs	20pcs	16pcs	8pcs



- 53604**
Split Pin Large Kit 144pcs

Linkage CBM Type

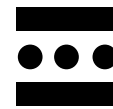

CBM S.p.A
COSTRUZIONI MECCANICHE

41738

Top Link CBM Cat 2 (15'Tube) Min 23' Max 31'
Landini Legend/Mc Cormack MC & MTX's



Waltersheid Quick Attach Hook Kits



61226

Quick Attach Hook Kit 6200 8200 Cat 3 Also fits John Deere



59039

Repair Kit Lower Link John Deere Ford Fiat Case Cat 3



63236

Lever Quick Attach CAT3 With Pin

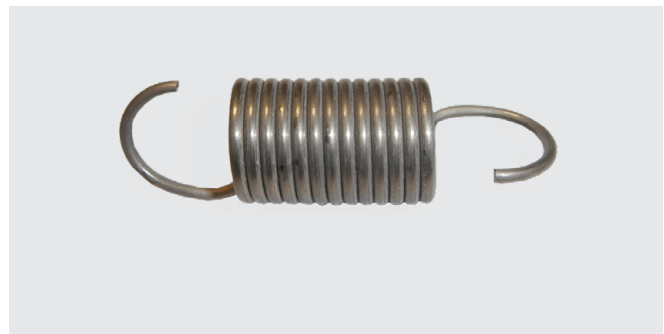

63237

Lever Spring Cat 2 Cat 3 Quick Attach



61227

Quick Attach Hook Kit 390 4200 6200 Cat 2 Also fits John Deere



59035

Quick Attach Hook Kit Massey Ford John Deere



QTP Catalogue range

www.qtponline.com

www.qtponline.de

www.qtponline.fr

www.qtponline.es

- > **Find Parts**
Find what you need quickly & easily
- > **Order Online 24/7**
Shop online 24/7 with our web shop. Get prices and check availability on over 16,000 tractor spares
- > **New Products**
New products & special offers
- > **Account Information**
See previous orders, statements and stock information

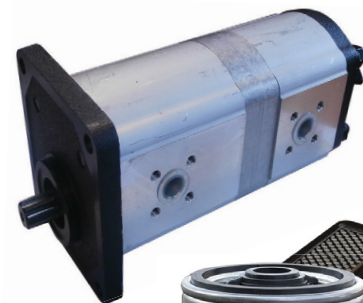

Distributors of:



Linkage CBM Type

CAT 2

41734

Quick Release End CBM type
Weld On Cat 2

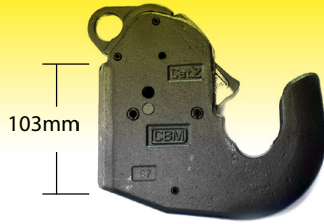

41735

Quick Attach Hook
Kit CBM Cat 2

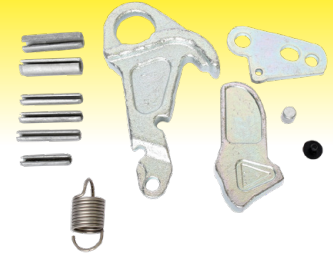

CAT 2S

41773

Quick Release End CBM CAT 2S
Weld On LH+RH

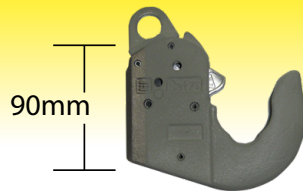

53839

Quick Attach Hook Kit
Cat 2S

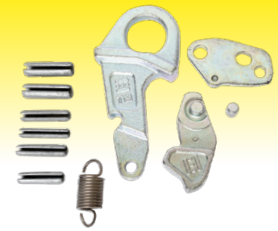

CAT 3

53381

Quick Release End CBM Weld
On Cat 3

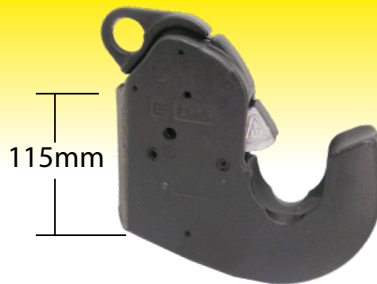

41736

Quick Attach Hook Kit
CBM Cat 3

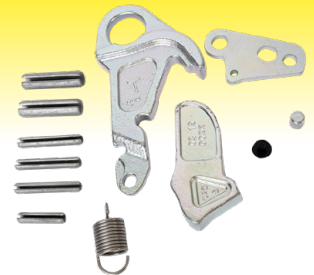

CAT 4

64444

Quick Release End CBM type
Weld on Cat 4
OE Ref: 3905500M91



53836

Cat 4 Quick Attach
Hook Kit CBM



WELD ON QUICK RELEASE ENDS - WALTERSCHEID

54890

Cat 2
OE Ref: 200016

54891

Cat 3
OE Ref: 200020

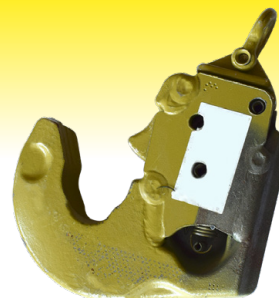

41739

Eye bolt Ring Quick
Release Chain 3000 5400



41746

Chain For Quick
Release CBM Type





4418
Link Ball Lower c/o Guide
Cone Cat 2
Pin To Suit 4419



4419
Linch Pin for 4418
12mm Diameter Pin



4727
LINK BALL Cat 3/3 & Guide
Cone *Pin To Suit 4419*

Cat 2 to Cat 3 Conversion Bush=53496



4729
Link Ball Cat 2/3 & Guide
Cone *Pin To Suit 4419*



62228
Ball Cat 2/2 For Lower Quick
Release End

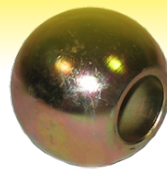

21018
Top Link Ball Cat 2/3



21019
Top Link Ball Cat 3/3

Cat 3 to Cat 2 Conversion Bush=53475



54455
Cat 2/3
Lower Link Ball
57mm OD 36.5mm ID 44.5 Width

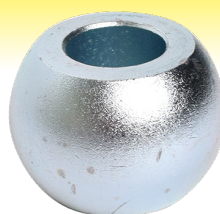

2539
Lower Link Ball Cat
3/2 ID 29 OD 63.5



2540
Lower Link Ball
Cat 3/3
ID 37.5mm
OD 63.5mm

*Cat 2 to Cat 3 Conversion Bush=53496
Lower Link Cat 2 to Cat 3 Conversion Bush=43155*

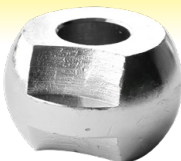

886428
Lower Link Ball Cat 1
Interchangeable
Fits 100 200 300 4200 4300
600 Series

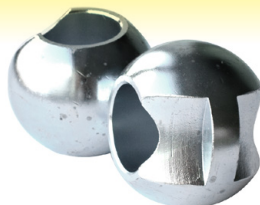

886429
Lower Link Ball Cat 2
Interchangeable
Fits 100 200 300 4200 4300
500 600 Series

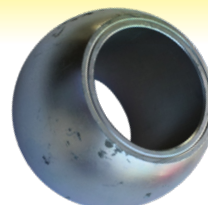

54688
Lower Link Ball Cat 4/4

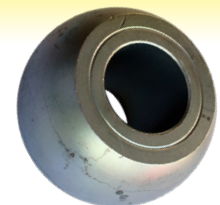

54689
Lower Link Ball Cat 4/3

Linkage CBM Type

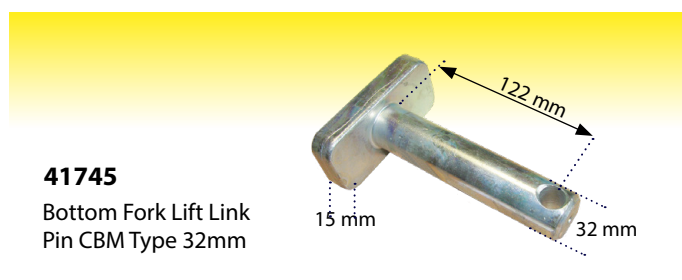
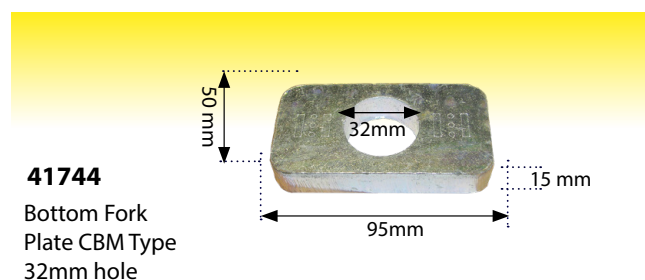
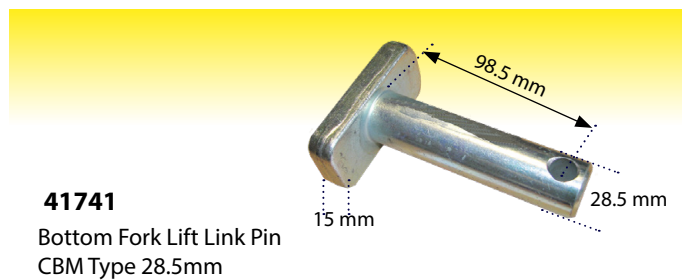
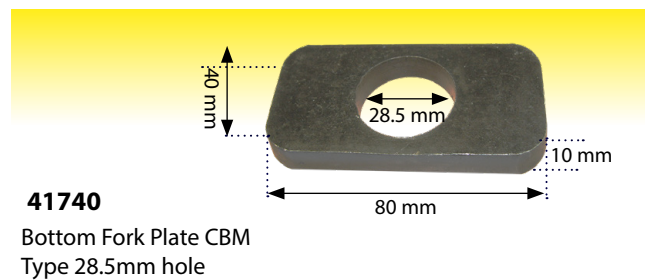
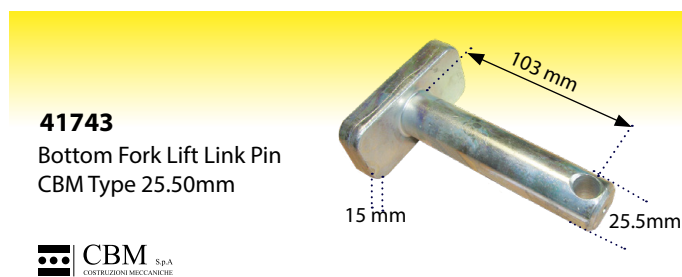
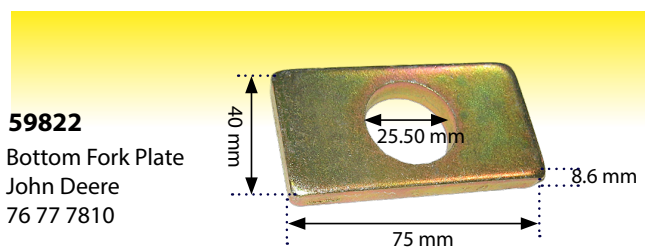
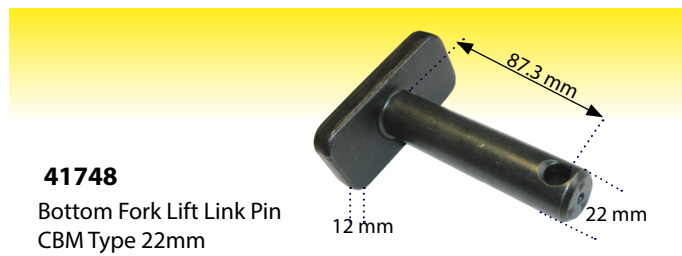
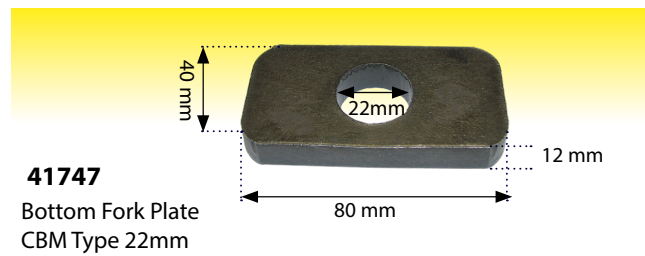
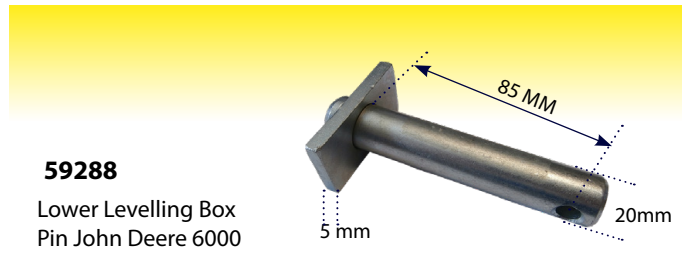
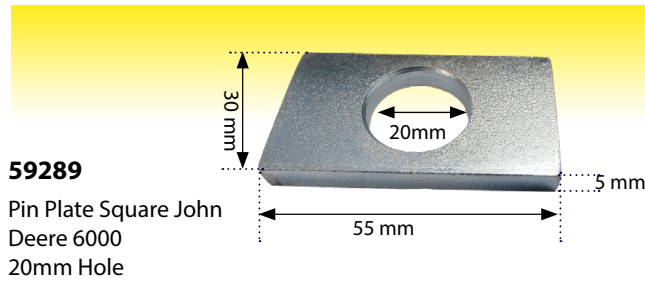

Linkage

62092

Levelling Box Fork 3000
Suits 61858
Pin is 41748

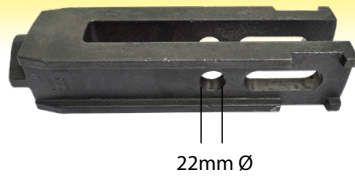

22mm Ø

6968

Lift Threaded Rod 3000 6000
180mm long x 26.5mm



186 mm

62091

Eye Bolt Assembly 3000 Levelling Box
Suits 61858



61858

Levelling Box 3050 3060 3065 6120 6130 6140
6235 6245 6255 6260 6265 6270 6280 6290
690mm long from centre of holes 22MM Pins

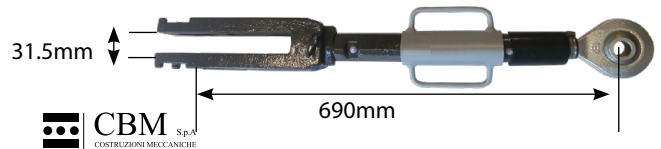

62063

Levelling Box 3645 3655 3670 3690 8120 8110
8130 8140 8150 8160 37mm Gap between Forks
770mm long from centre of holes
OE Ref: 3616478M91



55425

Levelling Box Assembly Deutz Agrotron106
- Agrotron 150 Agrotron 6.00 - 6.45
Case CS/CS Pro, CVX Series
OE Ref: 04419332



52143

Levelling Box Case 5120 - 5150
5250 - 5250 Maxxum 5100 & 5200 &
MX80 - MX135 (530-675mm)



DRSP30033

Pick Up Hitch Hook ISO 60mm
115mm btw Holes

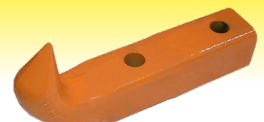

41739

Eye bolt Ring Quick Release Chain
3000 5400



52913

Linch Pin Safety
8mm

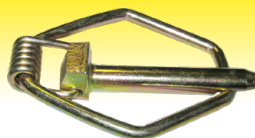

53027

Linch Pin Safety
10mm

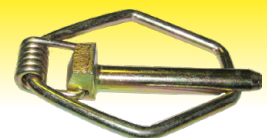

Lift Rods

DRP00001

Lift Rod Assembly John Deere & Bushing 20mm

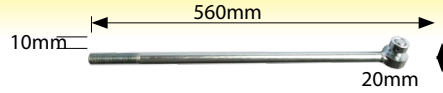

DRSP75265P

Lift Rod Fiat 90-90 Renault P25



DRP79044

Lift Rod 3000 3100 6100



DRSP6055

Lift Rod Ford TM 60

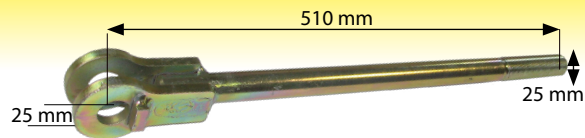

DRP79047

Lift Rod Case 844 955 956 1055 1055

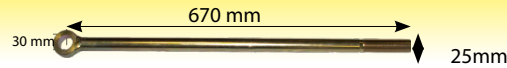

DRP79046

Lift Rod John Deere 7600 7700 7800

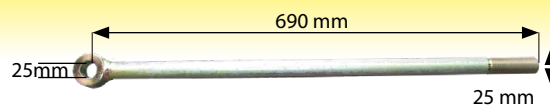

DRP75269

Lift Rod



DRP79032

Lift Rod John Deere 6810-6910



DRP43206

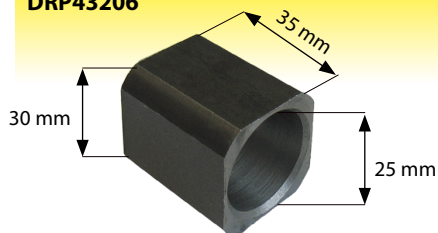

Spacer 35mm high

DRP44341

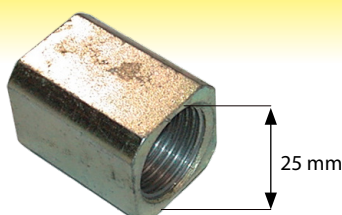

Nut Lift Rod 25mm Diameter

DRP44340

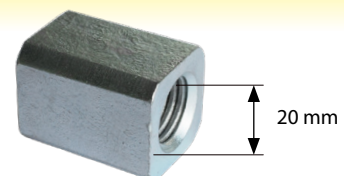

Nut Lift Rod 20mm Diameter

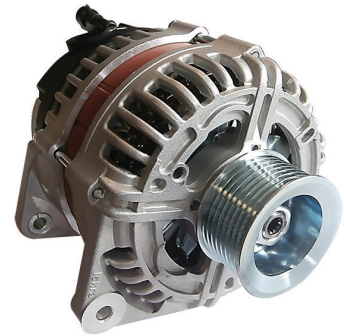

www.qtponline.com

www.qtponline.de

www.qtponline.fr

www.qtponline.es

› **Find Parts**

Find what you need quickly & easily

› **Order Online 24/7**

Shop online 24/7 with our web shop. Get prices and check availability on over 16,000 tractor spares

› **New Products**

New products & special offers

› **Account Information**

See previous orders, statements and stock information

Spool Valves



51615
Spool Valve Monoblock 1/2" BSP 4 Bank Double Acting, Double Acting, Double Acting Single Acting



51613
Spool Valve Monoblock 1/2" BSP 3 Bank Double Acting, Double Acting, Single Acting
In Kit 51660



3525
Spool Valve Monoblock 3/8" Double Acting Single Acting with Relief Valve



53101
Spool Valve Monoblock 1/2" BSP 1 Bank One Bank Double Acting



51614
Spool Valve Monoblock 1/2" BSP 2 Bank Double Acting, Single Acting



62744
Selector Valve with Spool Valve Monoblock 1 bank 3/8" BSP

52836 - Bolts

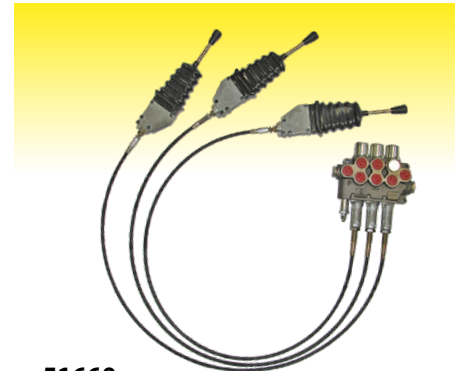

51660
Valve Block Fitting Kit, Cable & Handle 2.0 m

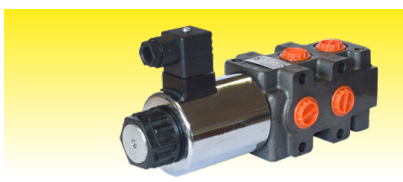

3874
Solenoid Six Port 1/2" with Din Plug 90 L/PM 65 WATT IP65 1/2 BSP



51768
DIN Connector For Solenoid Valve



52918
Dowty Washer M18



52922
Clamp for Hydraulic Accumulator *Suits 52920*



52921
Ball Valve High Pressure 3/8" BSP *Kit=51714*



51714
Hydraulic Actuator Easy Ride 250 Bar

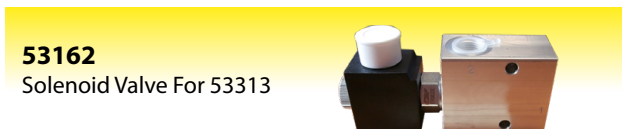

53162
Solenoid Valve For 53313



53313
Hydraulic Actuator Easy Ride Solenoid Control

Joystick Parts

51144
Joystick Lever
with Button &
Cable Fitted



51278
Push
Button for
Joystick with
Waterproof
Cover



51966
Joystick
Lever Ball



51146
Knob with
Switch to
suit Joystick
51144



51862
Base to
Suit Morse
Joystick
51144



53156
Push Button
For Joystick



3744
Cable Fitting Kit - Female Splined



3720
Cable Fitting Kit - Spade Spoon - Male

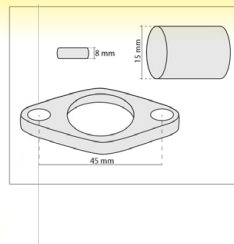

51333
Cable Connection



53157
Nut Hex For Joystick Button
51278



53158
Lock Washer For Joystick Button
51278



53159
Locking Ring For Joystick
Button 51278

Kontak Parts

1522
Double Acting
Kontak Slice

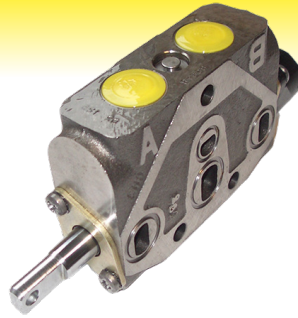

1954
Kontak End Cap



1091
Kontak Handle Bracket



1278
Pin & Link Kit Kontak Handle



4190
3/8" x 7 1/2" Stud



3534
Kontak End Cap
Long

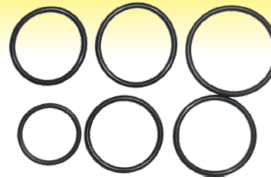

3116
O-Ring Kit Kontak Slice
Intersection



2447
Piston Seal Kit Kontak
New Type

3743
MORSE
ACTUATOR



2570
Kontak
Handle
Kit



51877
Morse Actuator
To Suit Hook
Type Cable



1204
Handle Kontak
Standard



Fitting Kit, Cable & Handle

Part No	Mtr
51663	1.5
51662	2
51671	2.5

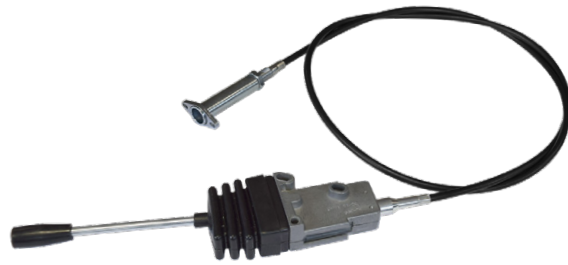

Quicke Loader Cable Threaded Ends

Part No	mm
53011	1200
53009	1500
53010	2000
53012	2400

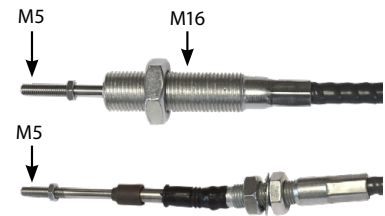

Quicke Loader Cable Ball & Rod End

55671
Cable Quicke Loader Ball &
Rod End 2000mm
[OE Ref: 5021030](#)



Quicke Loader Cable Ball & Eye Piece

Part No	mm
53013	1200
53000	1400
53001	1600
53002	1800
53003	2000
53004	2200
53005	2400
53006	2600
53014	3000
53008	3200

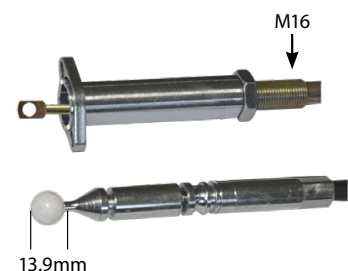

McConnel Hedge Cutter Cables

Part No.	Length	OE Reference	
54743	2000 mm	8019054	
54744	2500 mm	8019065	LOCKING
54739	3000 mm	8019066	
54740	3000 mm	8019031	LOCKING
54741	3200 mm	8019037	
54742	3500 mm	8019052	LOCKING

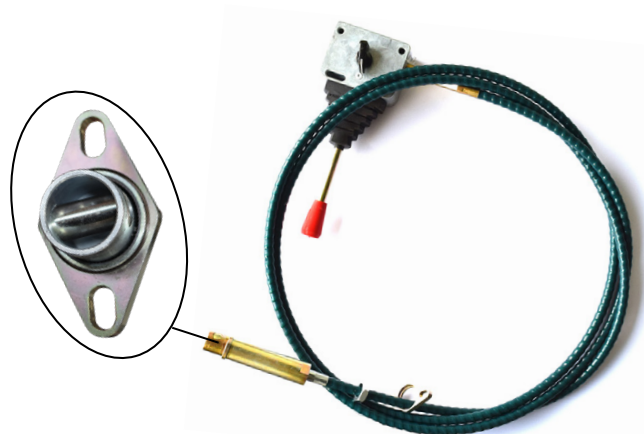

Chilton MX Loader Cables

Part No.	Length	OE Reference
54748	1.3MTR	300680
54749	1.5 MTR	300679
54750	1.8 MTR	300668
54751	1.2 MTR	300669
54752	2.4 MTR	300675
54753	2.8 MTR	300676
54754	3 MTR	300677
54755	3.2 MTR	300670
54756	3.4 MTR	300678
54757	3.6 MTR	300671
54758	3.8 MTR	300672
54759	4 MTR	300673
54760	4.2 MTR	300674



Morse Cable

Part No	Mtr
3732	1.5
3731	2
3736	2.5
3762	3

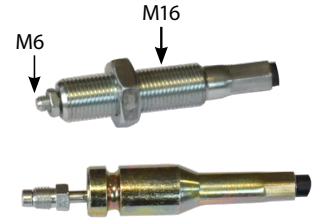

Morse Cable Hook Type

Part No	Mtr
51872	2.0
51873	2.5

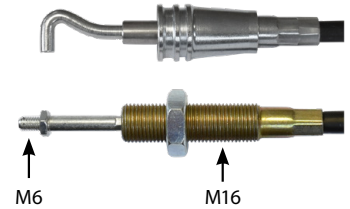

Cable for Joystick

Part No	Mtr
51337	1.5
51145	2
51220	2.5
54941	3

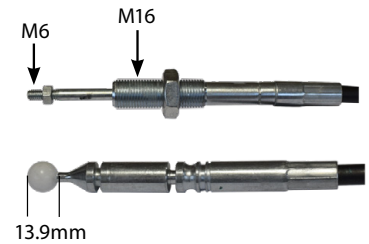

Loader Cable

59336

Cable Loader John Deere 531 - 551 533 - 583
631- 651- 661 633 - 653 - 663 731 - 751

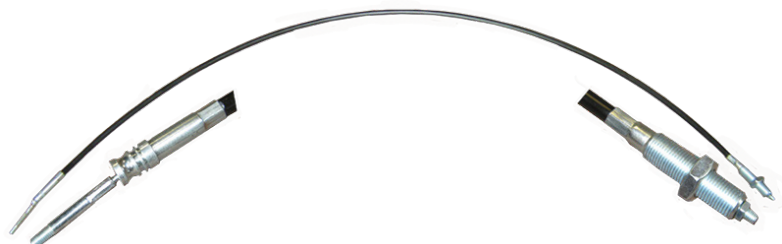

Hydraulic Filters



2411
Hydraulic Filter In line 3/4"



51888
Hydraulic Filter Head One Way 3/4 VCC



2146
Hydraulic Filter UCC
Fits JCB Forklift & Loader



1577
Hydraulic Filter Hedge Cutter



1595
Hydraulic Filter Hedge Cutter

Brake Components - Cup Seals

7136 - Cup Seal (28.6 x 7.2) Normal SRB

7140 - Cup Seal (31.7 x 7.2) Normal SRB



'O' Rings



1127
Box of Imperial "O" Rings

Gauges

3070

Gauge Pressure Small
5800 PSI Glycerine Fille



4378

Gauge Pressure 580 PSI
Glycerine Filled



3625

Gauge Oil Pressure 140
PSI Glycerine Filled



4470

Rubber Pressure
Gauge Protector



Valves

2749

Shut off Valve & Tap 3/8" BSP

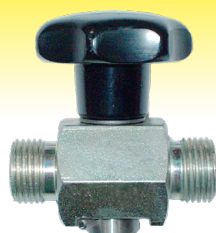

Adaptors

2257

Hydraulic Gauge
1/4' Barrell Adaptor



2258

Adaptor to suit
Hydraulic Gauge



1825

Adaptor 1/4' BSP x
3/8' BSP

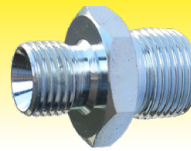

1852

Adaptor 1/2' x 1/4'
BSP



1893

UCC Oil Filler Cap
Assembly



Massey Ferguson Quick Release Couplings

6116	63151	63422
Suits: 300, 43, 43, 54, 61, 62 3000 64 Series Size: M22 OE Ref: 87381944	Suits: 62 and 82 Series OE Ref: 3909616M1	Suits: 5445 - 5480 6445 - 6499 6612 - 6616 7465 - 7499 7614 - 7626 CCLS OE Ref: 3796940M2

New Holland Quick Release Couplings

6116	41633	3029G
Suits: TS TM 60 Size: M22 OE Ref: 87381944	Suits: TS TM 60 Series Size: M22 OE Ref: 87381944	Quick Release Coupling Spool Valve OE Ref: 86508779

John Deere Quick Release Couplings

6116	59830	58250
Suits: 6000, 6010, 6020, 6030, 7030, 6R Series Size: M22 OE Ref: 87381944	10/20's Deluxe Version OE Ref: AL169345	1/2" Male Thread M18 x 1.5mm Suits: 40, 50, 55 Series OE Ref: 04327905

54790
QUICK RELEASE COUPLING
 1/2" FEMALE
 M22 X 1.5 THREAD LENGTH 26MM



Standard Quick Release Couplings

Size	Male	Female
3/8" BSP	1274	1275
1/2" BSP	1985	1984
3/4" BSP	1578	3624



Components

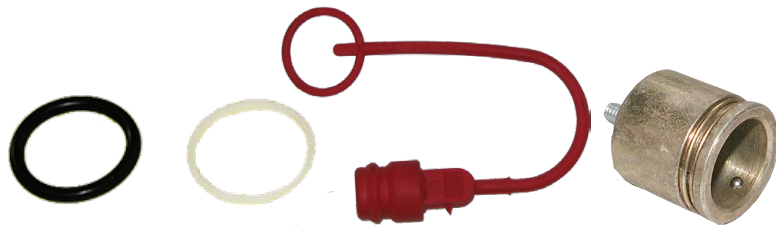

Size	Repair Kits	Dust Caps - Male	Dust Caps - Female	Anchor
3/8" BSP	1374	1612	1533	
1/2" BSP	3297	2759	1439	
3/4" BSP		1613	1662	
1" BSP			1665	

Pressure Washer Couplings

Size	Male	Female
3/8" BSP	2754	2753
1/2" BSP		2750



QUICK RELEASE COUPLING KITS	
Part No.	
55299	1/2" Male Female
55298	M22 Coupling With 1/2" Male Coupling



Breakaway Quick Release Couplings Kits

2559

Quick Release Coupling Assembly 1/2" 1/2"
DOUBLE BREAKAWAY KIT



2560

Quick Release Coupling Assembly 1/2" 1/2"
SINGLE BREAKAWAY KIT



Components



3272

Quick Release Coupling 1/2" BSP Female Push P



6957

Quick Release Coupling 1/2" 3/4" JIC Thread



1576

Quick Release Coupling Plate 1 Hole

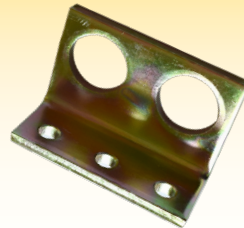

1744

Quick Release Coupling Plate 2 Holes



3968

External Circlip for 1/2" 38mm

Flat Faced Couplings

Size	Male	Female
3/8" BSP	53751	53750
1/2" BSP	51731	51732



Trailer Brake Couplings

Size	Female	Male - Brake Line	Female - Brake Line
3/8" BSP	2696		
1/2" BSP	2624	2748	
M18			2625
M20		2747	



Coupling Dowty

Male	Female	Dust Cap Male
51721 	51722 	51725 

Exactor

Female	Dust Cap Male
51727 	51730 

Bracket

61981

Bracket Multi Purpose For Hydraulic Couplers



Reusable

BSP Hydraulic Fittings

Couplings	Hose	Male	Female	90°
1/4" BSP	1/4"		1787	
3/8" BSP	3/8"	1789	1788	1789A
1/2" BSP	1/2"	1791	1790	1792
5/8" BSP	5/8"			
3/4" BSP	3/4"		1796	



JIC Hydraulic Fittings

Couplings	Hose	Male	Female
9/16" JIC	3/8"		
3/4" JIC	1/2"		
1 1/16" JIC	3/4"	5312	
1 3/16" JIC	3/4"		5309



JIC 90° Couplings

Couplings	Hose	Male	Female
1 1/16"	3/4"		
3/4"	3/8"		
7/8" 90	1/2"	1808	

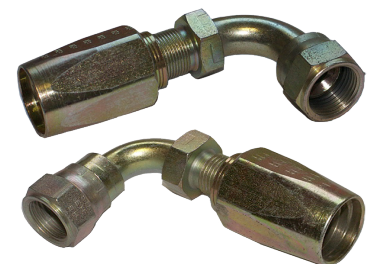

Metric Fittings

Couplings	Hose	Female
M22	1/2"	

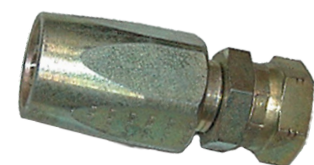

BSP Adaptors

Size	Male/Male	Female/Female	Male/Female
3/8" x 3/8"	1816	1861	
3/8" x 1/2"	1853	1859	1777
3/8" x 5/8"	1854		
1/4" x 1/4"	1828		1870
1/4" x 3/8"	1825	1860	
1/4" x 1/2"	1852		
1/4" x 3/4"	1851		
1/2" x 1/2"	1815	1856	1864
1/2" x 5/8"	1850		
5/8" x 5/8"		1895	1863
3/4" x 3/4"	1817		
1"x1"		1857	



JIC Adaptors



Couplings	Male/Male
1 1/16" JIC x 1 1/16" JIC	3616

JIC/BSP Adaptors



Couplings	Male/Male
9/16" JIC x 3/8" BSP	1827
9/16" JIC x 1/2" BSP	1826
3/4" JIC x 3/4" BSP	1989

Metric/BSP Adaptors



Couplings	Male/Male
18mm x 3/8"	2402
M22 x 1/2"	2386

BSP/JIC Adaptors



Couplings	Male/Male
9/16" JIC Male Male Hydraulic	54022

Bulkhead Adaptors

Size	Part No.
1/4" BSP	2645
3/8" BSP	1560
1/2" BSP	1170



Elbows



1135
3/8' x 3/8' BSP 90'
Comp. Elbow M & F



1198
Elbow Mass 1/2" x 1/2" BSP
90'

T Pieces

Size	Part No.
3/8" BSP Male	1269

1/2" BSP Female 3136



Female

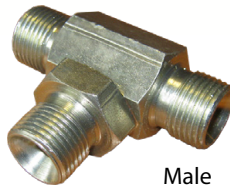

Male

Bulkhead Adaptors

Couplings	Male/Male
3/8" BSP	4271

1/2" BSP 4270

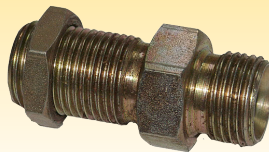

Size	Part No.
3/8" BSP	3294

1/2" BSP 3271



One Piece

Crimp on 3/8" BSP Fittings to suit 3/8" hose

Description	Part No.
-------------	----------

90° Sweep	2736
-----------	------

45° Sweep	2737
-----------	------

Female Parallel	2731
-----------------	------

Crimp on 1/2" BSP Fittings to suit 1/2" hose

Description	Part No.
-------------	----------

Female Parallel	2738
-----------------	------

Male Parallel	2730
---------------	------



www.qtponline.com
www.qtponline.de
www.qtponline.fr
www.qtponline.es



Tipping Pipes

1766

Tipping Pipe 24" - 1/2' Hose



61652

Tipping Pipe Kit
35 135



Dowty Washers

Part No.	Size
61792	1/8"
1693	1/4"
1527	3/8"
1526	1/2"
1528	5/8"
1525	3/4"



Hydraulic Hoses

Part No.	Size
2009	3/8"
2010	1/2" (2 Wire)
3570	3/4" (2 Wire)



HYDRAULIC HOSE ASSEMBLIES



Photo	Part No.	SIZE
3/8 SWIVEL		
2.	55428	0.5MTR 3/8 BANJO
2.	55429	0.75MTR 3/8 BANJO
2.	55430	1.00MTR 3/8 BANJO
2.	55431	1.25MTR 3/8 BANJO
1.	55384	0.5MTR
1.	55385	0.75MTR
1.	55386	1.00MTR
1.	55387	1.25MTR
1.	55388	1.50MTR
1.	55389	1.75MTR
1.	55390	2.00MTR
1.	55391	2.25MTR
1.	55392	2.50MTR
1.	55393	3.00MTR
1.	55394	3.25MTR
1.	55395	3.50MTR
1.	55396	3.75MTR
1.	55397	4.00MTR
1.	55398	4.25MTR
1.	55399	4.50MTR
1.	55400	4.75MTR
1.	55401	5.00MTR

Photo	Part No.	SIZE
1/2 SWIVEL		
1.	55402	0.5MTR
1.	55403	0.75MTR
1.	55404	1.00MTR
1.	55405	1.25MTR
1.	55406	1.50MTR
1.	55407	1.75MTR
1.	55408	2.00MTR
1.	55409	2.25MTR
1.	55410	2.50MTR

Radiator Caps



2083
Radiator Cap Massey Ferguson & Ford
10 Lb
OEM Ref: E2NN8100BA



61838
Radiator Cap Massey Ferguson 10 lb
Long Reach
OEM Ref: 885344M1



1874445
Radiator Cap 200 500
OEM Ref: 1874455M93

Fuel Tank Caps



61290
Fuel Tank Cap 20 TVO
OEM Ref: 825569M91



8002
Metal Fuel Tank Cap
100 Series David Brown
OEM Ref: 81718153



1876534
Fuel Tank Cap 500 690
OEM Ref: 1876534M91



61141
Fuel Tank Cap 3000 6100 8100
OEM Ref: 3041489M4

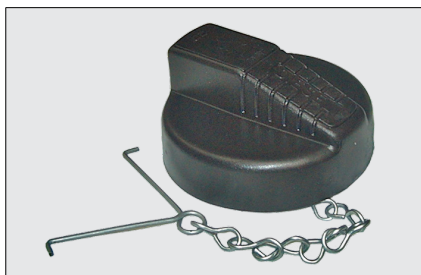

6021G
Fuel Tank Cap 300S - Non Lockable
OEM Ref: 1695732M1



61711
Fuel Tank Cap 300's Lockable Diesel
OEM Ref: 1695732M1

Fuel Tank Caps



62470
Fuel Tank Cap Lockable 3000 3600 8120 - 60



OEM

62147
Fuel Tank Cap 4225 - 4270 8210 - 8260
OEM Ref: [3782340M1](#)

Oil Filler Caps



768300
Transmission Oil Filler Cap Gearbox
OEM Ref: [181467M1](#)



2487841
Engine Oil Filler Cap
OEM Ref: [734962M91](#)



6142
Transmission Oil Filler Cap 600 300
OEM Ref: [3595359M92](#)



61492
Engine Oil Filler Cap
399 3100 3600 3085 3095
Twist Type
OEM Ref: [748219M1](#)



61493
Engine Oil Filler Cap
3100 3600 4200 4300
Screw Type
OEM Ref: [3641889M1](#)



62445
Oil Filler Cap
595 698 1080 1085 298 592
OEM Ref: [897105M1](#)

Ford Radiator Caps

41805



Radiator Cap
Fordson

41228



Radiator Cap Fordson
Super Major
OEM Ref: 81711544

4023



Radiator Cap Ford 7lb
OEM Ref: E2NN8100AA
83935904

4717



Radiator Cap Ford
13 Lb
OEM Ref:
E2NN8100BA

41877



Radiator Cap Ford TM120 -
TM190 22lbs
OEM Ref: 82033782

42029



Radiator Cap TM MXM
OEM Ref: 87306788

Fuel Tank Caps

41225

Engine Oil Filler Cap Dexta / Super
Major OEM Ref: 81717845



41473

Fuel Tank Cap Super Major
OEM Ref: 81718153



4079



Fuel Tank Cap Ford - All
Models
OEM Ref: 81811847
83904042

2775



Fuel Tank Cap Ford 7610
OEM Ref: E4NN9030AB

409660



Fuel Tank Cap Ford 40
Auxillary (91-98)
OEM Ref: 81874137

Oil Caps

1500

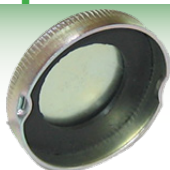

Oil Filler Cap Ford Power
Steering
OEM Ref: D2NN3A514B

4080

Oil Filler Cap
Ford Engine/
Transmission
OEM Ref:
83907851



4166

Transmission Oil Filler Cap
Dipstick Ford
OEM Ref: 81817892



41757

Filler Cap Ford - Transmission
OEM Ref: 957E7010



Fiat Oil Cap

7565

Engine Oil Filler Cap Fiat
100/90, Case JX, U
OEM REF: 4232606



7285

Fuel Tank Cap Fiat
OEM REF: 5105346



Fuel Tank Cap

John Deere Radiator Caps

59402



Radiator Cap John Deere 1640 - 3140
[OEM Ref: AL38374](#)

59394



Radiator Cap John Deere 940 3140
 1030 1630 2020 2120 3120
[OEM Ref: AL38374](#)

59389



Radiator Expansion Tank Filler Cap
 1350-2450 2650-3650
[OEM Ref: AL58894](#)

59395



Radiator Cap John Deere
 4040 4840 4050
[OEM Ref: AR76619](#)

59392



Radiator Expansion Tank Cap
 John Deere 6000
[OEM Ref: AL78005](#)

59397

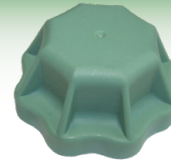

Radiator Cap John Deere 6000
 6010 6020 Filler
[OEM Ref: AL76661](#)

59400



Radiator Cap John
 Deere 7000 - 7020
[OEM Ref: RE43593](#)

Fuel Tank Caps

3158

Fuel Cap John Deere
 40 50
[OEM Ref: AL34678](#)



59840

Fuel Tank Cap John Deere
 00 10 20 Lockable
[OEM Ref: AL113087](#)



59436

Fuel Tank Cap John
 Deere 00 10 20 No
 Lock
[OEM Ref: AL113086](#)



Oil Caps

59391



Oil Cap John Deere 3050
 3350 3640 2140 1640 2040
[OEM Ref: R90788](#)

59390



Oil Cap John Deere 2040
 - 3640 Filler Neck
 Up To Serial Number
 429999 1350 - 2450 2650
 - 3650 All 6000 6010
 6020
[OEM Ref: R80136](#)

59401



Oil Filler Cap Engine
 John Deere

59361

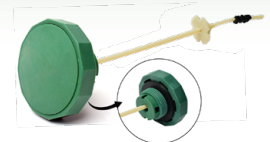

Oil Filler Cap Back End John
 Deere With Dipst 6100 - 6600
 6010 - 6610 6020 - 6620
[OEM Ref: AL163619](#)

Fuel Tank Caps

OEM

2503
Fuel Tank Cap
Zetor 6718 8011
OEM Ref: 955235



IHC Radiator Caps

52133
Round Radiator Cap
IHC



52020
Radiator Cap with Cover IHC
OEM Ref:1500626C92



2663
Fuel Tank Cap IHC
OEM Ref: 538063R1



52697
Fuel Tank Cap IH 42's
OEM Ref: 1500254C1

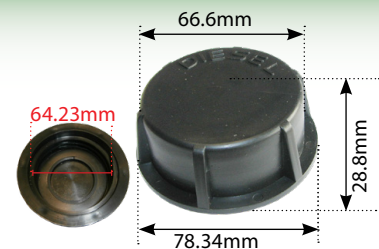

OEM

David Brown Oil Filler Cap

52731
Oil Filler Cap
David Brown



Exhausts - Clamps - Caps

Weathercaps



51807 2" 51mm
51204 2 1/4" 56mm
51198 2 5/8" 66mm
51195 3 1/4" 82mm



62801 1 3/4" 45mm



3415 70mm 2 3/4"
3264 82mm 3 1/4"



61579 240 43mm
3169 285 Rain Cap

Raincaps



62121
 Exhaust Clamp
 165 - OE Type
 59mm



61298
 Exhaust Clamp 35 135
 Lower Horizontal



62105
 Exhaust Clamp for
 Rear View Mirror 35
 Exhaust

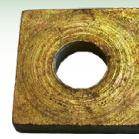

907155
 Washer 100 200 Exhaust
 Clamp Square



180070
 Exhaust Clamp 20 TVO
 Heavy Duty

Stainless Steel Rain Caps



53350
 1 3/4"
 44.45mm
 OD



53351
 2 1/4"
 57.15mm
 OD



53352
 2 1/2"
 63.5mm
 OD



53353
 2 3/4"
 69.85mm
 OD



53354
 3"
 76.2mm
 OD



53355
 3 1/2"
 88.9mm
 OD



53356
 4"
 101.6mm
 OD

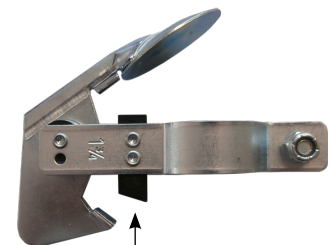

Nylon Buffer

Fuel Pumps

53787

Fuel Transfer Pump 12 Volt
Submersible 30 Litres per Minute

- 33litres per minute
- Pumps 5 meters high
- Worked off any 12v battery
- Removable filter for cleaning
- 40mm diameter
- CE approved



55222

Fuel Hand Primer Bubble
OE Ref: 9001-088A



53078

Fuel Pump 12 Volt
Eco Electric



55415

Fuel Hand Priming Kit



51476

Fuel Pump Lister HL4/HR
4 6 Cylinder



51477

Fuel Lift Pump Cummins
B's - Diaphragm Pump Case
Maxxum 5120 5130 5140



51478

Fuel Pump Land Rover 200 TDI

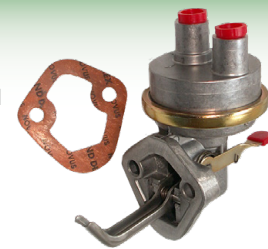

51479

Fuel Pump Land Rover 300
TDI

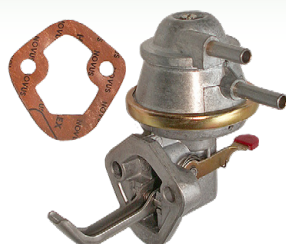

51484

Fuel Lift Pump Perkins 4/99
4.108 A4/107

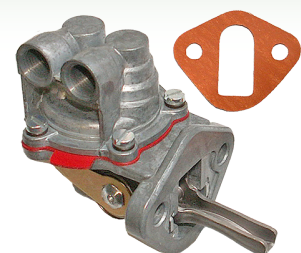

Diesel Stop Solenoids



1976
Solenoid 12v Diesel Stop
BOSCH Type



2038
Solenoid Diesel Stop
12V CAV Type 2 Spade
Connections



1992
Solenoid Diesel Stop
12V CAV Type Single
Nut Connection



62727
Solenoid 12V Diesel
Stop 42s 54s Plug In
Type

Valve Non Returns

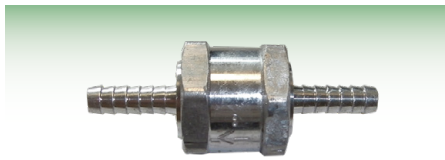

53317
Valve Non Return 6mm



59906R
Valve Non Return 8mm
59906 is genuine





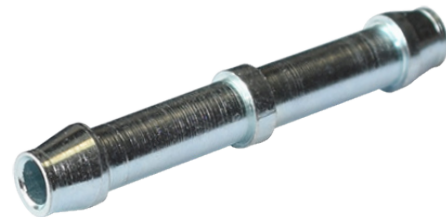

53318
Valve Non Return 10mm

PIPE JOINERS



Part No.	Description
53900	suits <i>3/16" ID Hose</i>
53901	suits <i>1/4" ID Hose</i>
53902	suits <i>5/16" ID Hose</i>
53903	suits <i>3/8" ID Hose</i>
53904	suits <i>1/2" ID Hose</i>
53905	suits <i>5/8" ID Hose</i>









NYLON FUEL LINE PIPES

Part No.	Description	
55337	1/4" Fuel Line Pipe Repair Kit <i>Includes 10 mtr Hose, Olives Fittings and Inserts</i>	
55338	5/16" Fuel Line Pipe Repair Kit <i>Includes 10mtr Hose, Olives Fittings and Inserts</i>	
3903-10	5/16" Fuel Line Pipe 10 Metre Roll	
3904-10	1/4" Fuel Line Pipe 10 Metre Roll	



STEEL FUEL PIPES

1917	Brake Pipe 3/16" (4.7mm) 10 Foot Length	
1910	1/4" (6mm) 10ft Length	
1905	5/16" 8mm	

RUBBER FUEL PIPES

2604	Fuel Hose 3/16" - 10 Mtr. Roll	
2605	Fuel Hose 1/4" - 10 Mtr Roll	
4526	Fuel Hose 1/4" - Per Mtr.	
2606	Fuel Hose 5/16" - 10 Mtr. Roll	
2607	Fuel Hose 3/8" - 10 Mtr Roll	
4528	Fuel Hose 3/8" - Per Mtr. 10mm x 17mm	

S TYPE FUEL PIPES

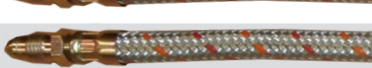
890145	30cm	
890137	50cm	
890138	60cm	
890140	70cm	
890146	80cm	
890141	90cm	
890142	100cm	

FUEL PIPE JOINERS

Part No.	Description	
62950	Brass 59mm Long	
3970	3/16'	
3971	1/4'	
3972	5/16'	
3973	3/8'	

FUEL LINE PIPE UNIONS

1924	5/16" Male	
1978	1/4" Male	
1974	Oil Pressure Male 3/8" UNF to suit 3/16" Pipe	
1973	Oil Pressure Pipe 3/16' F/M	

BARREL OLIVES

1721	3/16"	
1296	1/4"	
1297	5/16"	
3430	3/8"	

FUEL LINE REPAIR KIT

55517		
-------	--	--

Fan Belts

Massey Ferguson



Part No	Models	OE Ref	Size mm
62141	Fan Belt 20D 35 Narrow - 17 X 985 <i>V771 is the wide belt</i>		17 x 985
V771	Fan Belt 20D 35 4 Cylinder - 20 x 13 x 985 <i>62141 is the Narrow belt</i>	826960M1	17 x 985
2235	Fan Belt 35 3 Cylinder - 13 X 1175	828729M1	13 X 1175
2240	Fan Belt 135 7600 Double Pulley 13 X 1225 <i>Also 3000 Series Air con Belt</i>	890982M1	13 X 1225
2255	Fan Belt 165 188 Zetor Crystal - 13 X 1275	1447317M1	13 X 1275
4379	Fan Belt 365 375 390 - 13 X 1490	1693745M1	13 X 1490
6964	Fan Belt 399 Phaser - 13 x 1520 - PAIR	3614706M92	13 x 1520
6765	Fan Belt 399 A6.354.4 Pair	3595070M91	13 X 1440
3790	Fan Belt 200 500	81822583	13 X 1400
2240	Fan Belt 135 7600 Double Pulley *Also 3000 Series Air con Belt	890982M1	13 X 1225
1244	Fan Belt 698T Pair	1687610	10X1500
4381	Fan Belt 699 Pair	1688216M91	13 X 1445
2300	Fan Belt 2640 2680 Pair	3045111M91	13 X 1500
6766	Fan Belt 2640 3080 3090 Pair	3381364M91	13 X 1515
6898	Fan Belt 3125 3635 3645 6190 8110 Pair	3582953 M91	13 X 1575
429968	Fan Belt 42's With Air Conditioning Pair Green Engine 4225 4235 4240 4245 4255 4265	3817582M1	13 x 1400
429970	Fan Belt 42's High Visibility With Air Conditioning Green Engine 4225 4235 4240 4245 4255 4260	3815257M1	13 x 1295
62545	Fan Belt 5445 5455 5460 with Air Conditioning	3389525M1	13 x 1100
61380	Fan Belt 6245/6255 & 6260/6290 Pair 4260/4270 - 1405mm Long	3780606M91	13 x 1405
62538	Fan Belt 6260 6270 6280	3780138M91	13 X 1390
62539	Fan Belt 6260 6270 6280 with Air Conditioning	3386214M1	13 X 1150
2260	Fan Belt 240 Massey Ferguson 50B	3637306M91	13 X 1300

Fan Belts

Ford



Part No	Models	OE Ref	Size mm
1936	Cogged Belt Dexta		12.5 X 1125
2275	Fan Belt 2000 3000 4000 5000		13 X 1375
3790	Fan Belt 500's/Ford 600's S/P	81822583	13 X 1400
3370	Alternator Belt Ford 6600 7600 Double Pulley	D5NN10C3181C1	13 X 765
2240	Fan Belt 135 / 7600 Double Pulley		13 X 1225
4423	Fan Belt Double Pulley Ford 7600 7610	D6NN8620A	13 X 1145
4456	Fan Belt Ford 7610 7810 Short - AVX13 x 800	83948803	13 X 800
4254	Fan Belt Ford 7810 Late - Long	86514611	13 X 1150
4794	Fan Belt Ford 8210 TW5 15 25 35	89625879	13 X 1470
402914G	Fan Belt Ford 40 TS110 TS115 w/o Air Con Original	82850750	6PK 2217
402915G	Fan Belt Ford 40 TS110 TS115 with Air Con Original	82850752	6PK 2254
404857G	Fan Belt Ford TS 80 90 100 w/o Air Con Original	82850751	6PK 2225
404859G	Fan Belt Ford 81/82/83/8560 w/o Air Con Original	87316555	8PK 1475
41051G	Fan Belt Ford 8160/8260/8560/TM With Air Con Original	87309962	8PK 1951
41635G	Fan Belt Ford TSA 100-135, T6000 Original	4899178	8PK 1551

Fan Belts

Fiat



Part No	Models	OE Ref	Size
7310	Fan Belt Fiat 880	4712148	10 X 1275
7311	Fan Belt Fiat 80-90	4796650	10 X 1180
7312	Fan Belt Fiat 90-90 140-90 Pair	4796328	10 X 1140

Zetor



Part No	Models	OE Ref	Size
2255	Fan Belt Zetor Crystal	98419479	13 X 1275
1237	Fan Belt Zetor 8111		10 X 1225
B45	Fan Belt Zetor - up to 6718	974312 974318	

Leyland



Part No	Models	OE Ref	Size
2260	Fan Belt Leyland		13X1300

Universal



Part No	Models	OE Ref	Size
2032	Fan Belt Universal		12.5 x 1150

Fan Belts

Deutz



Part No	Models	OE Ref	Size
3492	DX610-110-85		9.5 x 1560

Case



Part No	Models	OE Ref	Size
1509	Fan Belt IHC 474 784	3616512M91	13 x 1550
52002	Fan Belt Case 956/1056 w/o Air Conditioning	3218952R1	13 x 1420
52006	Fan Belt Case 4240	1537104C1	13 x 1595
52085	Air Con Belt Case CX70 CX80 CX90	228332A2	13 x 930
52776	Fan Belt Case C90 CX90 C100 CX100	241895A2	10 X 1415
52775	Fan Belt Case Magnum 7120 7150 7210 7250 8PK1700	J911567	8PK 1700
52774	Fan Belt Case MX150 MX170 - 5130 5140 5150 8PK1460	J911558	8PK 1460

David Brown



Part No	Models	OE Ref	Size
3475	Fan Belt David Brown 990/1410	K68073	10 X 1175
52176	Fan Belt David Brown 3 Cylinder	K912196	10 x 1090

Fan Belts

John Deere

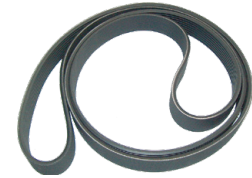
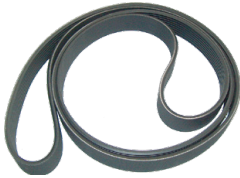

Part No	Length	Air Breaks	Air Con	Models	Tension
59907G	2190mm	No	Yes	6800 6900 8PK2190	Mech
59947G	2205mm	No	Yes	6100 6200 8PK2205 Original 6300 6400 6600 & All SE	Mech
59948G	2225mm	No	Yes	6100 6200 6300 6400 6600	Hyd
59949G	1718mm	No	No	6100 6200 6PK1718 6300 6400 6506 6600 Premium 6100 6200 6300 6400 SE models	Mech
59950	1700mm	No	No	6600 6800 6900 6PK1700 6506 6600 6800 6900 - W/O Air Con	Mech
59950G	1700mm	No	No	66 68 6900 6PK1700 6506 6600 6800 6900	Mech
59889G	1930mm	No	No	6010 6020 4 Cyl 8PK1930 6110 6210 6310 6410 6120 6220 6320 6420	Mech
58676	2200mm	No	No	6800 6900 8PK2200	Mech
59063	2285mm	Yes	Yes	6100 6200 6300 6400 6800 6900	Hyd
59694G	2460mm	No	Yes	6100 - 6610 M/ten 8PK2460 & A/C 6120 6130 SE and Premium Tractors	Mech
59387	2500mm	Yes	Yes	6810 6910 6910S 8PK2500 For 6810 6910 with Air Brake & Air Con 6230 6330 6430 with Air con up to Serial Numb (98-27/64")	Mech
59375	2455mm	No	Yes	6820 c/o Air Con 8PK2455 6820 - 6920S 6230 - 6930	
58675	773mm			Alternator Belt John Deere 6930 - 7530 Premiu	

Fan Belts

John Deere



Part No	Length	Air Breaks	Air Con	Models	Tension
59539	2365mm	Yes	No	6810,6910,6910S,6230,6330	Mech
59540G	1900mm	No	No	6810 6910 6910S 6230 6330	Mech
59541	2515mm	YES	Yes	6310, 6410, 6510, 6610, 6520, 6620, 6130, 6630	Mech
59542	1915mm	No	No	6510,6610,6130	Mech
59543	1910mm	Yes	No	6820,6920,6920S,6230,6930	Mech
59544	2375mm	Yes	No	6820,6920,6920S,6230,6930	Mech
59545	2505mm	Yes	Yes	6820,6920S,6930	Mech
59375	2440mm	No	Yes	6820,6920S,6230,6930,2455	Mech



Part No	Length	Air Breaks	Air Con	Models	Tension
59321	1120mm	No	No	2020 2120	Mech
59320	1215mm	No	No	1020 1120 1520 2120 1030 1130 1630 2020 2120 1830 2030 2130	Mech
59319	1328mm	No	No	3120 3130 3030 1640-2040	Mech
59325	1397mm	No	No	2250 - 2850	Mech
59324	1447mm	No	No	3300-3410 2250-2650	Mech
59317	1460mm	No	No	3040 3140 X17X1460	Mech
59323	1473mm	No	No	3100-3210 2350-2850	Mech
59322	1540mm	No	No	3050 3350	Mech

High Tensile Steel Bolts

UNC

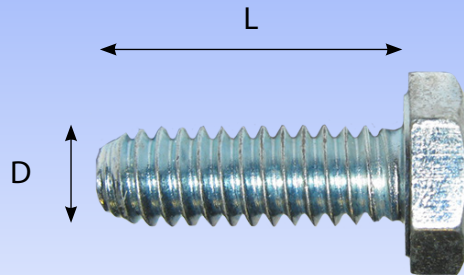

D →	1/4"	5/16"	3/8"	7/16"	1/2"	5/8"	3/4"	7/8"
L ↓								
3/4"	353667	353677						
1"	353669	353679	353691	353698	353723			
1 1/2"	353673	353683	354262	353702	353724	353726		
1 1/4"								
1 3/4"								
2"		353687	353897	353706	354280	353728	354710	4669
2 1/2"	3568	354615	354269	353710	354651	353937	354714	3770
3"	354611	354619	354271	353714	354655	353730	3846	3847
3 1/2"			3289	353718	3203			
4"				353722	3888	354296	354726	
4 3/8"								
4 1/2"						353636		
5"						3896		

3629
M14 x 100 Coarse Bolt



High Tensile Steel Bolts

UNF

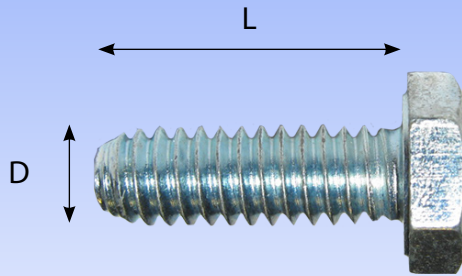

L\D	1/4"	5/16"	3/8"	7/16"	1/2"	5/8"	9/16"	3/4"	7/8"	1"
3/4"	353503	353517								
1"	353505	353519	353538	353559	354393					
1 1/2"	353509	353525	353542	353563		353611				
2"	353513	353527	353546	353567	353599	353615		1025	3849	3199
2 1/2"	354491	353531	353550	353571	353887	353619		3200	3850	
3'	354768	353535	353554	353575	353890	353623	3096	354571	3851	3852
3 1/2"			354505	353579	353602	353627		354573		
4"				353583	353892	353631		894034	2282	
4 1/2"			2876			353636				
5"				353591	4656	353639		354582		
5 1/2"						353643				
6"						3706				
7"						353655				
8"						353894				
9"						357322				
10"						3566				

High Tensile Steel Bolts

METRIC

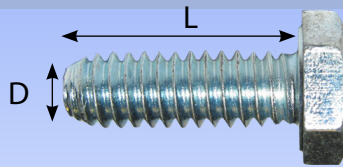

D\L	Type	25	30	40	45	50	65	75	80	100	120	140	150
M3		4475											
M4													
M5				51021									
M6	Chess H. Screw					4479							
	Coarse					3007		3591		3597			
M8	Fine	1550			353605	1551	1552						
	Coarse	3008	2727			3009		3598		3993			
M10	Fine	1553				1558	353654		1564				
	Coarse		3010			3011			3012		3013		
M12	Fine	3664				1565			1566	1569			
	Coarse					3048		3049		3619			
M14	Fine	3684				1873	3737 1.5p						
	Coarse		3637			3757		1424					
M16	Fine	3695		1874		1697	3696			1877			
	Coarse	2728				3014		3015		3016	51622		3018
M18	Fine												
	Coarse					2097			2101	2100			
M20	Fine												
	Coarse						3019		3020	3021			
M22	Fine							353561					
	Coarse												

Metric Nuts & Washer





	Nuts Coarse	Nyloc Nut Coarse	Nuts Fine	Nuts Fine Lock	Flat Washer
					
M3	4481				
M4	4482				
M5	4490	51022			
M6	3001				3515 51948
M8	3002	1987	1579	3723	3517 51945
M10	3003	1699	1580	3724 1.25p	51946
M12	3050	1223	1587	3547 (1.25p) 3734 (1.5p)	51947
M14	1423 3990	1995			51944
M16	3004	1996 53348	3709		51950
M18	2084	353603 53347			51951
M20	3005	1998 53346			51949

52893

Shear Bolts Pack
M8 x 55mm

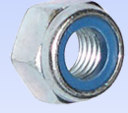

Nut & Washers

	Unc Nuts 	Unc Lock Nuts 	Flat Washer 	Spring Washer 	UNF Nuts 	Unf Lock Nuts 
1/4"	355564	375107	353754	353441	353918	376446
5/16"	355565 3995	376453	353770	353446	353916	
3/8"	355566	2003	353771	353434	353431	353430
7/16"	355645	376455	353772	353432	353426	353428
1/2"	375098	357560	353773	353439	353437 51932	353438
9/16"					3223	
5/8"	375099	357562	353774	353433	353427	353429
3/4"	375100	3567	353762	353440	353435	353442
7/8"	375101		1061	3661	3439	
1"	1105		1067		3224	
1 1/4"			1366			
1 1/2"			1001			

Threaded Bars & Steel Keys

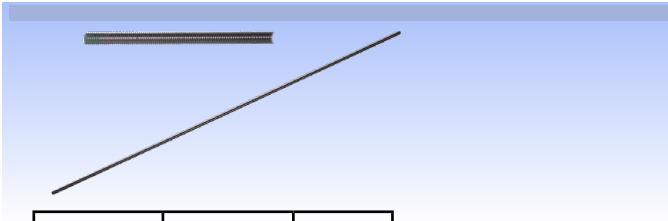

Ref		Mtr
51308	Fine	8
51309	Coarse	10

Metric Threaded Bars



53071	M10 x 50mm
53073	M12 x 80mm

Steel Keys Metric

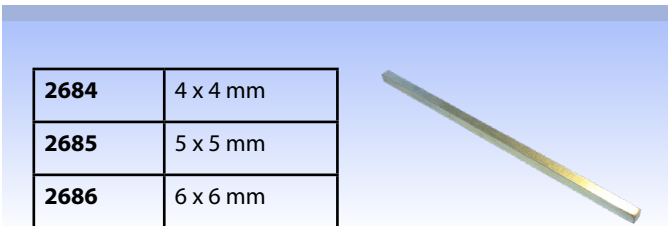

2684	4 x 4 mm
2685	5 x 5 mm
2686	6 x 6 mm

Imperial

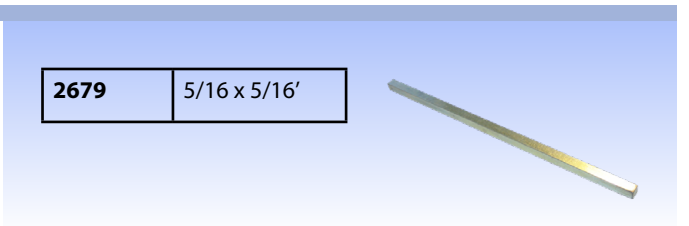

2679	5/16 x 5/16'
------	--------------

Thread Lock

1043
Loctite
Thread
Lock 50 ml



55499
LOCTITE 510
OE Ref:3900613M2



1472
Split Pin 5mm x 75mm

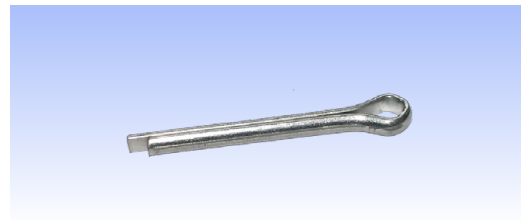

53040
Cotter Pins 6.3 x 75mm

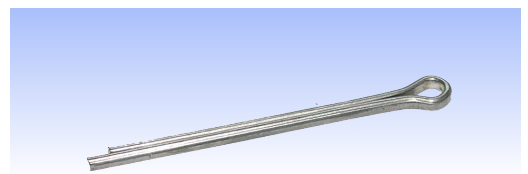

Single Row Ball Bearings

NACHI

60 Series

Ref	ID	OD	WD
60012RS	12	28	8
60032RS	17	35	10
60042RS	20	42	12
60052RS	25	47	12
60062RS	30	55	13
6006ZZ	30	55	13
60072RS	35	62	14
60082RS	40	68	15
60092RS	45	75	16
60102RS	50	80	16
60112RS	55	90	18
60142RS	70	110	20
60152RS	75	115	20

62 Series

Ref	ID	OD	WD
62012RS	12	32	10
62022RS	15	35	11
6202ZZ	15	35	11
62032RS	17	40	12
62042RS	20	47	14
62052RS	25	52	15
6205ZZ	25	52	15
62062RS	30	62	16
6206ZZ	30	62	16
62072RS	35	72	17
6207ZZ	35	72	17
62082RS	40	80	18
62092RS	45	85	19
62102RS	50	90	20
6212ZZ	60	110	22
62132RS	65	120	23
62172RS	85	150	28

63 Series

Ref	ID	OD	WD
63002RS	10	35	11
63012RS	12	37	12
63022RS	15	42	13
63032RS	17	47	14
63042RS	20	52	15
6304ZZ	20	52	15
63052RS	25	62	17
6305ZZ	25	62	17
63062RS	30	72	19
63072RS	35	80	21
63082RS	40	90	23
63092RS	45	100	25
6309ZZ	45	100	25
63102RS	50	110	27
6310ZZ	50	110	27
6312ZZ	60	130	31
63142RS	70	150	35

Bearings

Ref	Size
RMS8	1" x 2.5" x 0.75"
30202	15 x 35 x 11mm
18690/20	46 x 79.38 x 17.46mm



Ref	Size
31308	40 x 90 x 25.25mm
32306	60 x 110 x 22mm
31309	45 x 100 x 27.25mm
32309	45 x 100 x 38.25mm
53415	75 x 160 x 69mm



Single Row Ball Bearings

High Speed

Ref	ID	OD	WD
6009C3	45	75	16
6207C3	35	72	17
6210C3	50	90	20

17 Series

Ref	ID	OD	WD
1762092RS	45	85	19
1762102RS	50	90	20

600-620-630 Series

Ref	ID	OD	WD
6082NSL	8	22	7

Taper Roller Bearings

302 Series

Ref	ID	OD	IW	OW
30204JR	20	47	14	12
30205	25	52	15	13
30206J	30	62	16	14
30207J	35	72	17	15
30208J	40	80	18	16
30209J	45	85	19	16
30210J	50	90	20	17
30211	55	100	21	18
30212J	60	110	22	19
30213	65	120	23	20
30215	75	130	25	22

303 Series

Ref	ID	OD	IW	OW
30303J	17	47	14	12
30304J	20	52	15	13
30305	25	62	17	15
30306JN	30	72	19	16
30309J	45	100	25	22
30310J	50	110	27	23
30311	55	120	29	25
30312	60	130	31	26
30313	65	140	33	28
30314	70	150	35	30
30315	75	160	37	31

322 Series

Ref	ID	OD	IW	OW
32206JR	30	62	20	17
32207J	35	72	23	19
32208JR	40	80	23	19
32211	55	100	25	21
32215	75	130	31	27

Bearing Inserts & Pillow Blocks

Bailer Bearing Inserts

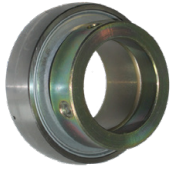

	Ref	ID (MM)
Greasable	GE30KRRB	50

Bearing Inserts



REF	ID
UC207	35mm
UC20824	1 1/2"

Ram Bushes



Ref	ID (mm)	OD (MM)
4213	17	30
7459	20	35
7306	25	42
4277	40	62
4287	50	75
4309	60	90
4310	70	105

Locking Collars

Part No. Dimensions

53697 ID 3/8" OD 3/4" x 3/8" BZP

53698 ID 7/16" OD 7/8" x 7/16" BZP

53699 ID 1/2" OD 1" x 7/16" BZP

53701 ID 3/4" OD 1 1/14" x 9/16" BZP

53702 ID 7/8" OD 1 1/2" x 9/16" BZP

53703 ID 1" OD 1 5/8" x 5/8" BZP

53704 ID 1 1/8" OD 1 3/4" x 13/16" BZP

53705 ID 1 1/4" OD 2" x 7/8" BZP

53706 ID 1 3/8" OD 2 1/8" x 7/8" BZP

53707 ID 1 3/4" OD 2 5/8" x 1" BZP

53708 ID 2" OD 3" x 1 1/8" BZP

53709 ID 10mm OD 20mm x 10mm BZP

53710 ID 15mm OD 25mm x 12mm BZP



53711 ID 20mm OD 32mm x 14mm BZP

53712 ID 22mm OD 36mm x 14mm BZP

53713 ID 25mm OD 40mm x 16mm BZP

53715 ID 35mm OD 56mm x 16mm BZP

53716 ID 40mm OD 63mm x 18mm BZP

53717 ID 45mm OD 70mm x 18mm BZP

53718 ID 50mm OD 80mm x 18mm BZP

53719 ID 60mm OD 90mm x 20mm BZP



Bolt Flanges

54591	UCF205 4 BOLT FLANGE 25MM
54592	UCF206 4 BOLT FLANGE 30MM
54593	UCF207 4 BOLT FLANGE 35MM
54594	UCF208 4 BOLT FLANGE 40MM
54608	UCF209 4 BOLT FLANGE 45MM
54609	UCF210 4 BOLT FLANGE 50MM
54610	UCF211 4 BOLT FLANGE 55MM
54611	UCPE205 PILLOW BLOCK 25MM

Pillow Blocks

54612	UCPE206 PILLOW BLOCK 30MM
54613	UCPE207 PILLOW BLOCK 35MM
54614	UCPE208 PILLOW BLOCK 40MM
54615	UCPE209 PILLOW BLOCK 45MM
54616	UCPE210 PILLOW BLOCK 50MM



Ref	ID
UCF205-16	1'
UCF208-24	1 1/2'
UCFX13E-40	1 3/4'
UCF210	



Ref	ID
UCP206-18	1 1/8'
UCP207-20	1 1/4'
UCP208-24	1 1/2'

PZ107
PZ Hay Bob Tine (Narrow Blue)

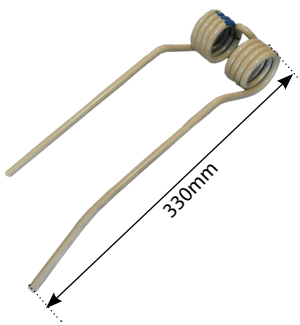

PZ106
PZ Hay Bob Tine (Narrow Yellow)

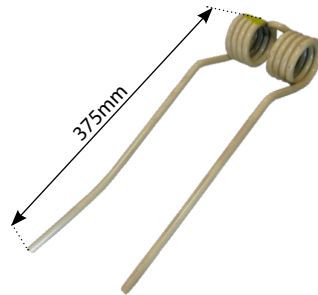

PZ110
PZ Hay Bob Tine (Wide Blue)

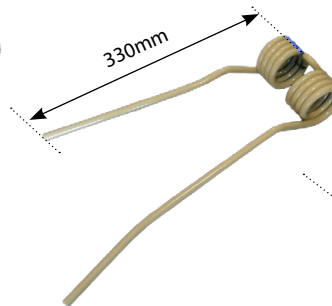

PZ111
PZ Hay Bob Tine Wide Yellow

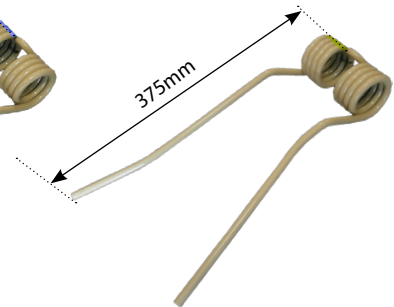

PZ99
PZ Hay Bob Spring LH

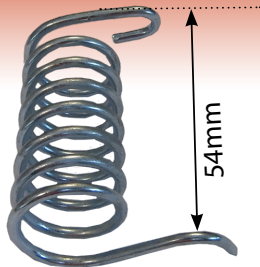

PZ100
PZ Hay Bob Spring RH

CM120
PZ 105 x 47 Blade



817062
Coupler Thompson Finger Mower

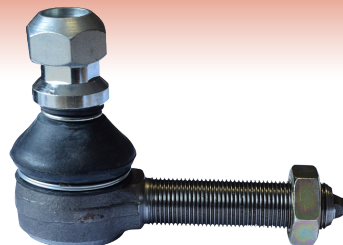

53898
Bush Thompson Finger Mower Coupler



59249
Amalgamating Tape Black
0.25mm Thickness



53126
Silage Tape Black
50mm x 25m



51830
Silage Tape Black PVC
75mm x 20m



3871
Fuel Filter Central
Heating

TOPPER BLADES

Suits :

Belmac Conor Malone Fleming Wylie Nugent Bridgeway Quinn Rossmore Toppers



53144
Topper Blade 13' x 5/16' 26mm
Right Hand



53149
Topper Blade 13' x 5/16' 32mm
Left Hand



43257
Topper Blade Major 30mm Hole 270mm
Long Clockwise

53148
Topper Blade 13' x 5/16' 32mm
Right Hand

43256
Topper Blade Major 30mm Hole 270mm
Long Anticlockwise

55419
Topper Blade Bushes
Suits Topper Blade 53144
OE Ref: [ABY9130](#)



55421
Rubber Topper Shaft
Drive Coupling
OE Ref: [ABY9063](#)



51189
Flail Spiral Pin 11mm Howard



51188
Flail Plate 4 x 2.5"
Howard



3934
Flail 3/8" x 15 Link Chain Spreader



3880
Flail Head 1/2" Rotary Spreader
Howard



3254
Flail Head 3/8" Howard

1391
Grab Hook 5/16"



52894
Grab Hooks 11mm 860kgs



Airline Fittings Hose Parts

53382

Coupling Y Air 1/2" UNF



1333

Hose End 1/4'
BSPT Male 1/4'



1362

Coupling Y Air Twin



	Male	Female
1/4" Bayonet		1328
1/4" BSP	1092	1113



Airline Gauge

51855

Airline Gauge Mk 3 Twin
Hold On Open End PCL



Tyre Parts

2527

Rear Tube Nozzle



1396

Valve Dust Cap



51150	45mm	Small Round Patch
3727	60mm	Medium Round Patch
3729	100 x 50mm	Medium Oval Patch
3274	130 x 130mm	BP 4 Patch
1118		No. 5 Patch
2524	125mm	No. 6 Round Patch



53021

Brass Valve



52859

Tyre Repair Kit
Tubeless



52861

Tyre Valve Opener



51069

Valve Female For Tube

51851

Tyre Valve
Connector PCL
Single clip on
open end

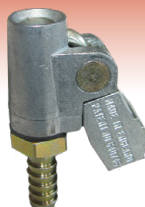

52860

Valve Tyre



51551

Air Compressor Hose with Fitting (to Tyre) 16 Bar 5.5m Long



2418

Air Compressor with 13ft Hose - 6 Mtr In wooden box Connector is 51734



2576

Piston Ring Compressor 3"



51734

Connector for 2418 Compressor



53290

Wire Brush Drill Mounted 75 x M14

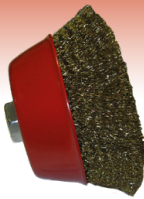

53291

Wire Brush Drill Mounted 120 x M14



53286

Wire Brush Circular 75mm



53292

Wire Brush Twisted Steel



53289

Wire Brush 3 Pack

53288

Vice Grip Straight Jaw



53283

Turbo Torch Self Ignite



59250

Crimping Tool



54623

Spanner Combination Set 25pcs 6mm - 32mm



Assortment Packs

53596

Roll Pin Imperial Kit
315pcs



Size	5/32" x 5/8"	1/4" x 5/8"	5/16" x 3/4"	5/64" x 1/4"	1/16" x 3/16"	3/32" x 5/8"	1/8" x 5/8"	3/8" x 3/4"	7/32" x 1.25"	3/16" x 5/8"
Qty	10	10	10	10	10	10	15	5	10	15
Size	5/32" x 1"	1/4" x 1.25"	5/16" x 1.5"	5/64" x 1/2"	1/16" x 3/4"	3/32" x 1.75"	1/8" x 1"	3/8" x 1.5"	7/32" x 1.75"	3/16" x 1"
Qty	10	10	10	10	10	10	15	5	10	15
Size	5/32" x 1.5"	1/4" x 1.75"	5/16" x 2"	5/64" x 1"	1/16" x 5/16"	3/32" x 1.25"	1/8" x 1.25"	3/8" x 2"	7/32" x 5/8"	3/16" x 1.25"
Qty	10	10	10	10	10	10	15	5	10	15

53601

Hex Head Drill Screw Kit
200pcs



Size	#8 x 3/4"	#8 x 1"	#8 x 1/2"	#8 x 5/8"	#10 x 1/2"	#10 x 5/8"	#10 x 3/4"	#10 x 1"
Qty	30	30	30	30	20	20	20	20

53597

Woodruff Key Metric
80pcs



Size	5/32 x 5/16 x 3/4	3/16 x 5/16 x 3/4	1/8 x 5/16 x 1/2	1/8 x 1/4 x 5/8	5/32 x 3/16 x 1/2	5/32 x 1/4 x 5/8	3/16 x 3/8 x 13/16	1/4 x 3/8 x 13/16
Qty	10	10	10	10	10	10	10	10

51843

Roll Pin Kit Metric
2.5 x 24mm - 8 x 55mm



53609

Parallel Key
Imperial Kit
60pcs



Assortment Packs

53600
Wing Nut Kit
Metric 150pcs

Size	$\frac{3}{16}$ - 24	$\frac{3}{16}$ - 32	$\frac{1}{4}$ - 20	$\frac{1}{4}$ - 28	$\frac{5}{16}$ - 28	$\frac{5}{16}$ - 24
Qty	30	30	25	25	20	20

53607
S Proof & Spring Washers 720pcs

Size	6#	8#	10#	$\frac{1}{4}$ "	$\frac{5}{16}$ "	$\frac{3}{8}$ "	6#	8#	10#
Qty	50	50	50	40	30	20	50	50	50
Size	$\frac{1}{4}$ "	$\frac{5}{16}$ "	$\frac{3}{8}$ "	6#	8#	10#	$\frac{1}{4}$ "	$\frac{5}{16}$ "	$\frac{3}{8}$ "
Qty	40	30	20	50	50	50	40	30	20

53606
Circlip Internal
External Kit 225pcs

Size	$\frac{7}{16}$ "	$\frac{5}{8}$ "	$\frac{1}{2}$ "	$\frac{9}{16}$ "	$\frac{5}{8}$ "	$\frac{3}{4}$ "	$\frac{1}{2}$ "	$\frac{3}{4}$ "	1- $\frac{1}{4}$ "
Qty	15	15	15	15	15	15	10	10	5
Size	1"	$\frac{7}{8}$ "	$\frac{13}{16}$ "	$\frac{9}{16}$ "	$\frac{13}{16}$ "	$\frac{7}{16}$ "	$\frac{3}{8}$ "	$\frac{5}{16}$ "	$\frac{1}{4}$ "
Qty	10	10	10	10	10	15	15	15	15

Assortment Packs



53592

Grease Nipple Kit
Imperial 110pcs

Size	1/4 - 28	1/4 - 28 45°	1/4 - 29 90°	1/8 - 27 90°	1/8 - 27 90°	1/8 - 27
Qty	30	15	15	15	15	20



53604

Split Pin Large
Kit 144pcs

Size	3.2 x 50	3.9 x 63	4.7 x 75	6.3 x 50	6.3 x 25	7.9 x 63
Qty	50	30	20	20	16	8



53593

Grease Nipple Kit
Metric 110pcs

Size	M6 x 1 straight	M10 x 1 straight	M8 x 1.25 straight	M6 x 1 45° straight	M8 x 1 45° straight	M10 x 1 45° straight	M8 x 1 straight	M6 x 1 90°	M8 x 1 90°	M10 x 1 90°
Qty	50	10	5	5	10	5	10	5	5	5

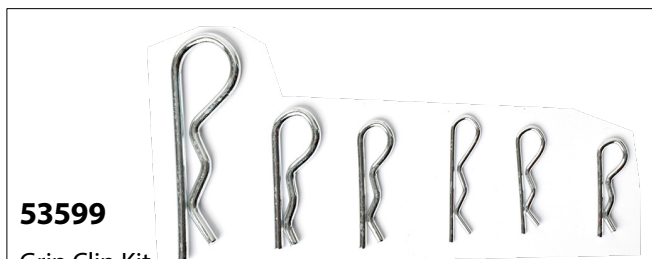

53599

Grip Clip Kit
150pcs

Size	2.38x30.1	1.98x33.34	1.98x39.69	2.78x41.37	3.57x44.45	3.96x75
Qty	42	30	25	25	20	8



51860

Circlips Assorted Internal and
External Metric



53602

Split Pin & Grip Clip Kit
260pcs

Size	5/32x2 1/2	1/8x2	3/32x1 1/2	3/32x1	3/16x1	5/64x1 5/16	5/64x1 9/16
Qty	20	20	50	50	50	20	20



55694

Flat Mudguard Washer
Assortment Box

Assortment Packs

53598
Fuse Blade & Tool Kit 93pcs
Includes Tester and Removal Tool

Size	5 Amp	10 Amp	15 Amp	20 Amp	25 Amp	30 Amp
Qty	15	15	15	15	15	15

52900
Fuse Mini Blade Tool Kit 90pcs
Includes Tester and Removal Tool

Size	5 Amp	10 Amp	15 Amp	20 Amp	25 Amp	30 Amp
Qty	15	15	15	15	15	15

53605
Spring Ext & Comp Kit 200pcs

Size	FIRST FRACTION - OUTSIDE DIAMETER			SECOND FRACTION - LENGTH				
	Comp. 12.7 x 7.14 Ext. 20.6 x 5.1	Comp. 6.35 x 10.3 Ext. 55.5 x 25.4	Comp. 55.5 x 17.46 Ext. 6.35 x 22.2	Comp. 9.52 x 15.8	Ext. 7.93 x 28.5	Comp. 9.52 x 19.05	Ext. 7.93 x 31.7	Ext. 8.73 x 46.8
Qty	10	10	10	6	8	12	10	12
Size	Ext. 7.93 x 44.4	Ext. 7.14 x 50.8	Ext. 3.96 x 79.3	Comp. 9.1 x 34.9 S 1011 Ext. 4.76 x 44.4	Ext. 7.14 x 38.1	Comp. 5.55 x 38.1	Comp. 7.14 x 19.05 S 1016 Ext. 8.73 x 36.5	
Qty	12	12	12	8	10	10	10	

53594
Washer Copper Metric Kit
150pcs

Size	5x10	8x12	11x17	6x10	10x16	14x18	7x10	10.5x17	12x20	12.5x20	15x20	16.5x24	14x20	16x22	17.5x24
Qty	10	10	10	10	10	10	10	10	10	10	10	10	10	10	10

53608
O Ring Kit Imperial
80pcs

Size	2.9x1.78	3.69x1.78	4.47x1.78	5.52x1.78	6.07x1.78	6.75x1.78	7.66x1.78	8.73x1.78	9.25x1.78	10.82x1.78	11.11x1.78	12.42x1.78
Qty	25	25	25	25	25	25	25	25	25	25	25	25

Assortment Packs

52902

Pre Insulated Terminal Kit
260pcs



Size	22-18ga Bullet Male Connector MPD 1.25-156	22-18ga Bullet Female Disconnect FRD 1.25-156	22-18ga Male Connector MDD 1-250	22-18ga Female Disconnect FDD 1-250	22-18ga Female Disconnect FDD 1-110 (5)	22-18ga Female Disconnect FDD 1-187 (5)
Qty	20	15	20	20	20	20
Size	16-14ga Bullet Male Connector MPD 2-195	16-14ga Bullet Female Disconnect FRD 2-195	16-14ga Male Connector MDD 2-250	16-14ga Female Disconnect FDD 2-250	16-14ga Female Disconnect FDD 2-187 (5)	16-14ga Female Disconnect FDD 2-250
Qty	15	15	15	15	20	10
Size	12-10ga Bullet Male Connector MPD 5.5-195	12-10ga Bullet Female Disconnect FRD 5.5-195	12-10ga Male Connector MDD 5-250	12-10ga Female Disconnect FDD 5-250	22-18ga Female Disconnect FDFD 1-110	22-18ga Female Disconnect FDFD 1-187
Qty	10	10	15	15	10	15

52903

Pre Insulated Terminal Kit
160pcs



Size	12-10ga Ring Terminal 5.5-5	12-10ga Male Connector	22-18ga Ring Terminal 1.25-4	22-18ga Butt Connector	16-14ga Ring Terminal 2-5L	16-14ga Spade Terminal 2-4M
Qty	4	5	8	12	10	10
Size	12-10ga Ring Terminal 5.5-8	12-10ga Female Disconnect	22-18ga Quick Splice	18-14ga Quick Splice	16-14ga Ring Terminal 2-4L	16-14ga Bullet Male Connector
Qty	4	5	4	4	10	10
Size	12-10ga Ring Terminal 5.5-10	12-10ga Butt Connector	18-14ga Butt Connector	16-14ga Ring Terminal 2-6	16-14ga Bullet Male Connect & Female Disconnect	16-14ga Bullet Female Disconnect
Qty	4	12	18	10	2 x 10	10

Assortment Packs

53603

Clevis Pin Kit 60pcs

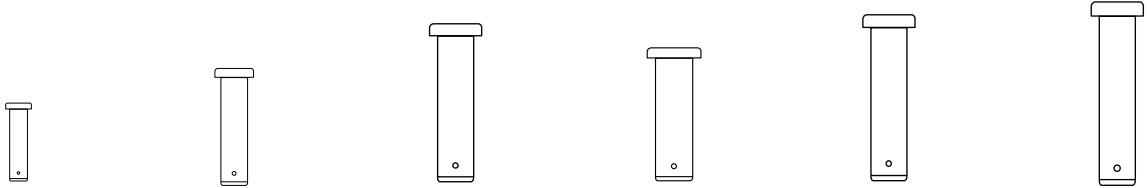

Qty	3/32" Hole	Qty	3/32" Hole	Qty	1/8" Hole	Qty	1/8" Hole	Qty	5/32" Hole	Qty	5/32" Hole
4	3/16 x 1	3	1/4 x 1-3/4	3	5/16 x 1	2	5/16 x 2	4	3/8 x 1		
4	1/4 x 1	3	1/4 x 2	3	5/16 x 1-1/4	2	5/16 x 2-1/4	3	3/8 x 1-1/2	2	1/2 x 1-1/2
3	1/4 x 1-1/4	3	1/4 x 2-1/4	4	5/16 x 1-1/2	1	5/16 x 2-1/2	2	3/8 x 2	2	1/2 x 2
4	1/4 x 1-1/2	3	1/4 x 2-1/2	3	5/16 x 1-3/4	2	5/16 x 2-3/4				



55562

Accessory Pack Kit

Included	53592	53593	53594	53598	53599	53602	53605	55340	55341	55342	55343	55344
Qty	3	3	2	3	2	2	1	1	1	1	1	1
Included	55345	55346	55347	55348	55349	55350	55351	52902	53608	53604	52900	
Qty	1	1	1	1	1	2	1	2	1	2	2	

Assortment Packs



51840
Fibre Washers Assorted
METRIC



52909
Fibre Washer Handy Pack
ImpERIAL



52910
Fibre Washer Vulcanised
Handy Pack



53220
Copper Washer Kit Imperial



53307
Olives Stepped & Barrell
Imperial 500pcs



53219
O Ring Kit Metric



51876
Safety Goggles



51735
Mutton Cloth 100% Cotton



52862
Gloves Maxitherm Orange
Size 10



52863
Gloves Maxiflex Black Size 10



51841
Latex Gloves Lightly
Powdered



53085
Rags 10kgs

55678
Inverter Welder 200amp



51823
Welding Rods Mild Steel
3.2mm



Garage Equipment



53280
Sanding Pad 4 Inch 40 Grit

53303
Sanding Pad 4 Inch 120 Grit



51822 Cutting Disc 9 Inch

51825 Cutting Disc Steel 4 1/2'

51827 Grinding Disc Steel 4 1/2'

53282 Cutting Disc 115mm x 1.0 22mm



53076
Radio CD Player JVC



53277
Radio CD Player JVC With Bluetooth



53077
Speakers 180 Watts 10cm x 10cm - PAIR



4537
Rubber Aerial 24cm



52916
Rubber Aerial 40cm



51081
Aerial Extension Cable 150cm



51082
Aerial Extension Cable 200cm



53406
Torch 30 Lumen Krypton Spotlight

53734
Tec 7 Glue Mount & Seal 310ml InBlack Colour



53735
GT 7 Penetrating Oil & Moisture Repellent 600ml



52858
WD40 Smart Straw 600ml



53125
WD40 White Lithium Grease High Performance 400ml



53760
Novastop Radiator Radiator Sealer Pump Sealer Engine Block

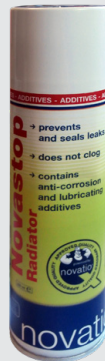

53761
Novaflush Engine Powerful Engine Flush



52192
WD40 Smart Straw 400ml













51835
Spray Glue



52866
Gasket Maker Red Aerosol



<p>1073 Tin of Solution for patch</p>		<p>1491 Tube of Solution for tyre patch</p>	
<p>53305 Tube of Solution for tyre patch</p>		<p>53087 Water Weld</p>	
<p>53740 Tyre Sealer OKO 1250ml Ideal for Lawnmowers, Quads, Tractors, Earthmovers</p>		<p>53016 Tiger Seal Adhesive 310ml Cartridge</p>	
<p>53667 Gasket Maker Silicone High Temperature 35g</p>		<p>53668 Gasket Maker Silicone High Temperature 85g</p>	
<p>53666 Gasket Remover 400ml</p>		<p>53665 Bars Seal Stopper 25g For Cooling System Up To 15ltrs</p>	
<p>51757 Easy Start - Bradex</p>			

Farmer's Friend



52839
Farmers Friend Machinery Cleaner 5ltr



52840
Farmers Friend Anti Bac Hand Soap 5ltr



52841
Farmers Friend Milk Stone 5ltr



52846
Farmers Friend Beaded Hand Cleaner 4kg



52856
Grease 500g Copper



52853
Tar & Glue Remover 5Ltrs



53368
AdBlue 20 Litre Fuel Additive



52854
Car Polish 5Ltr



52851
Chainsaw Oil 20Ltr



53239
Degreaser Heavy Duty 1 Litre



53284
Gas Refill 450gr



55541
Brake Fluid



55539
Two Stroke 1 Litre



55540
Two Stroke 5 Litre



Emery Cloth Grades
51216 - 50 mtr Roll x 50mm Grade 80
51215 - Grade 40



51849
Wire Brush



51833
Filter Wrench



52885
Antifreeze Tester

Grease Guns



2132
Grease Gun & Flexi Hose & Chuck



3663
Grease Cartridge
400g Lithium



3665
Grease 400 Gr. Cartridge EP2



55315
Grease MP Brown CTG
30 x 500G Maxol

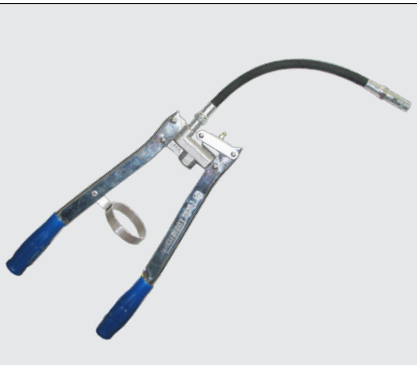

51814
Grease Gun Fuchs Reiner



51812
Grease 500g Rockman GP2



51813
Grease 500g EP Lithium LZR 2



3712
Grease Gun & Rigid Hose & Chuck



53749
Grease Gun Heavy Duty



53026
Grease Gun Mounting Bracket

QTP Catalogue range

www.qtponline.com

www.qtponline.de

www.qtponline.fr

www.qtponline.es

- › **Find Parts**
Find what you need quickly & easily
- › **Order Online 24/7**
Shop online 24/7 with our web shop. Get prices and check availability on over 16,000 tractor spares
- › **New Products**
New products & special offers
- › **Account Information**
See previous orders, statements and stock information



Distributors of:



Grease Guns & Pumps



1062
6' Bent Rigid Tube



2128
H/D 4 Jaw Grease
Gun End



4539
Grease Gun Flexi Hose
Extensio

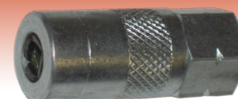

1272
Grease Gun End - 4 Jaw

1291 Grease Gun Hose 12'
2664 Grease Gun Hose 18"
2665 Grease Gun Hose 24"



Grease Nipples

51289
Grease Nipples Assorted
Pack 10 pcs

FLAT53422
Grease Nipple M8 x 1.25mm

51290
Grease Nipples Assorted Pack Ford
(10 pcs)

FLAT53421
Grease Nipple M8 x 1mm



1626	1/8"	Bsp 45 Hydraulic Grease Nipple
1588	1/8"	Bsp 45 Hydraulic Grease Nipple
200191	1/4"	Unf Straight Hydraulic Grease Nipple
1670	1/4"	Bsp 45 Hydraulic Grease Nipple
1694	1/4"	UNF 90 Hydraulic Grease Nipple
29958X	1/4"	UNF 45 Hydraulic Grease Nipple
1287	5/16"	UNF Straight Hydraulic Grease Nipple
1144	3/8"	UNF 45 Hydraulic Grease Nipple
2906	3/8" 45"	BSP Grease Nipple



45°

Straight

90°

Cans & Funnels

1544
Metal Oil Can &
Flexi Tube



1544L
Oil Can QTP



3551
Funnel with Filter &
Flexi Extension



3476
Funnel 220mm & Filter



3545
Funnel & Diesel Filter
(Water Separator)



Can Flexi Spout Measures

3479	5 Ltr.
-------------	--------



Linch Pins

53057
Linch Pin & Grip Clip Assortment Pack Qty 50

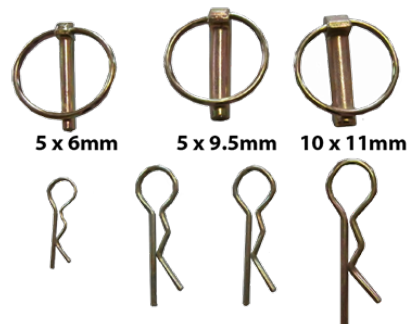

Workwear



Gibson Jacket

WESTARO14 XXL



Royal Blue Boilersuits

WESTARO9 42"
WESTARO10 44"
WESTARO12 48"
WESTARO13 50"
WESTARO16 52"



WESTARO8 Polo Shirt Small
WESTARO6 Polo Shirt Large
WESTARO7 Polo Shirt XL

54571
 Trolley Jack 3 Tonne



54570
 Hydraulic Bottle Jack 4 Tonne



2871
 Bottle Jack 30 Tonne





6613
Socket 3 Pin - 2 Bolt Fixing Cobo



6626
Plug 3 Pin Cobo Also fits
John Deere 00 10 20



6628
Socket 3 Pole - 4 Bolt Fixing Cobo
Also John Deere & Case



52612
Plug 4 Pin 5-9mm Cable



52611
Socket 4 Pin 5-9mm Cable



51980
Handle Bar Switch Quad



2610
Switch Push Button 20amp Heavy
Duty - M25 Plastic Screw Terminals



53229
Heater Plug In

Universal Joints



Ref	Description	Size DxL	Grease Nipple	GUA Ref
1220	Universal Joint	22 X 54	Nipple in the Centre	Gua3
1448	Universal Joint	22 X 55	Nipple in the Centre	Gua4
4389	Universal Joint	22 x 59	Nipple in the Centre	GU7800
1216	Universal Joint (20.00.00)	23.8 x 61.2	Nipple in the Centre	GUA5
1921	Universal Joint 50HX/ZF 4WD 11.01.00	27 x 70.5	Nipple in the Centre	GUA7
409820	Universal Joint Ford 40 Carraro	27 x 71.7	No Nipple	
1449	Universal Joint - 21.00.00	27 x 74.6	Nipple in the Centre	GUA8
2382	Universal Joint 300 4WD Fiat	27 x 82.3	Nipple on the Side	GU1000A
409746	Universal Joint Ford New Holland TL TLA TMTS TSA T6	27 x 81.5	No Nipple	
1881	Universal Joint (3.10.80)	30 x 81.7	Nipple in the Centre	GUA10
2855	Universal Joint ZF APL 345 4WD Axle	30.2 x 82	No Nipple	
61399	Universal Joint 50H 50HX 60H	30.2 x 106.3	Nipple on the Side	GU2050
3836	Universal Joint	30.2 x 80	Nipple in the Centre	GUA11
1450	Universal Joint 399 (22.00.00)	30.2 x 92	Nipple in the Centre	gua12
6824	Massey Ferguson 698/698T/699//36'S/590/59	30.2 X 92	No Nipple	

Universal Joints

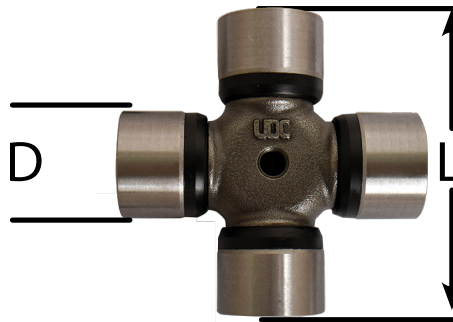

Ref	Description	Size DxL	Grease Nipple	GUA Ref
1218	Universal Joint (23.00.00)	30.2 x 106.5	Nipple in the Centre	GUA13
1880	Universal Joint 35.00.00	32 x 76	Nipple in the Centre	gua14
4960	Universal Joint Ford TW5 TW15 TW25	34 x 97	Nipple in the Centre	
1217	Universal Joint (24.00.00)	34.9 x 106.4	Nipple in the Centre	gua17
2315	Universal Joint	38 x 105.8	Nipple in the Centre	
1219	Universal Joint Ford County	39.7 x 115.9	Nipple on the Side	GU3500
3073	Universal Joint (36.00.00)	36 x 89	Nipple in the Centre	gua20
350600	Universal Joint Wide Angle Shaft	32 x 76 / 27 x 94	Nipple in the Centre	GUA-5
62861	Universal Joint 4200 4300	27 x 71	No Nipple	
59055	Universal Joint John Deere 2140 2850 6100	28.5 x 71.3	No Nipple	
51690	Universal Joint ZF Axle APL1251 1351 315 345 30 x 83	30 x 83	No Nipple	
43579	Universal Joint New Holland	30.17 x 106.28	No Nipple	
43570	Universal Joint New Holland T7030 T7040 T7050	30.3 x 107.2	No Nipple	
59033	Universal Joint John Deere 1840 2040 2850	35 x 97	Nipple in the Centre	
52285	Joint Case 2120 2130 2140 2150 3210	23.76 x 62.64	Nipple in the Centre	
58278	Universal Joint John Deere 2140 2850	28 x 71.5mm		AL62452

Universal Joints



PTO GUARDS

54590	PTO GUARD LEVER RELEASE	54596	PTO GUARD LEVER RELEASE 1100MM
54595	PTO GUARD LEVER RELEASE 1500MM	54597	PTO GUARD LEVER RELEASE 1500MM





PTO SHAFTS

54598	PTO SHAFT 800MM 1.3/8Z6 X 1.3/8Z6QR	54603	PTO SHAFT 1400MM 1.3/8QR X 1.8/8Z6QR
54599	PTO SHAFT 1000MM 1.3/8Z6 X 1.3/8 Z6QR	54604	PTO SHAFT 1250MM 1.3/8Z6 X 1.3/8Z6QR
54600	PTO SHAFT 1100MM 1.3/8Z6 X 1.3/8Z6 QR	54605	PTO SHAFT 1500MM 1.3/8Z6 X 1.3/8Z6QR
54601	PTO SHAFT 1400MM 1.3/8Z6QR X 1.3/8Z6QR	54606	PTO SHAFT 1400MM 1.3/8Z6 X 1.3/8Z6QR
54602	PTO SHAFT 1200MM 1.3/8Z6 X 1.3/8Z6QR	54607	PTO SHAFT 1400MM 1.3/8Z6 X 1.3/8Z6QR



P.T.O. Shafts - Walterscheid

<p>51064 PTO Shaft 10 Series 610mm</p>	
<p>W21610 Walterscheid Shaft with Slip Clutch</p>	
<p>59644 PTO Shaft Safety Guard Lever Release 1500mm x 82mm</p>	
<p>59645 PTO Shaft Safety Guard Lever Release 1100mm x 82mm</p>	
<p>55417 PTO Shaft T60 - QRSB C/W Shear Bolt 1510mm OE Ref: CCM0763312710</p>	
<p>55418 PTO Shaft T80 - 1510EN - C17 - BQ2 C/W Shear Bolt OE Ref: COM0783506110</p>	

P.T.O. Guards

	
<p>52911 Chain Assy PTO Guard</p>	<p>4946 PTO Guard 11 3/8"</p>

Slurry

	
<p>55675 Valve with Ram & Spring 4 Bolt Slurry Tank 55673 Flanged Rubber Gasket 4 Bolt Slurry Tank</p>	<p>55674 6" Male with Flange 4 Bolt OM Italian Slurry Tank</p>

Crosses & End Tubing - Walterscheid

21.06.00

Wide Angled Cross

A - 27 mm
D - 27 mm
B - 91 mm
C - 74.5mm

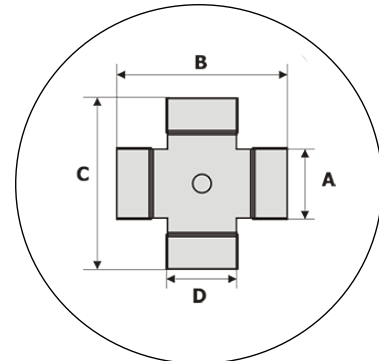

Series 35



35.10.02
Tractor End Yoke



4811
PTO Repair Shaft 1 3/8" x 6 - 300mm



51385
PTO Release Button 47.0mm



51386
PTO Release Button 13 x 45mm
Tin Head



51384
PTO Release Button 1 3/4"



51383
PTO Release Button 74.5mm

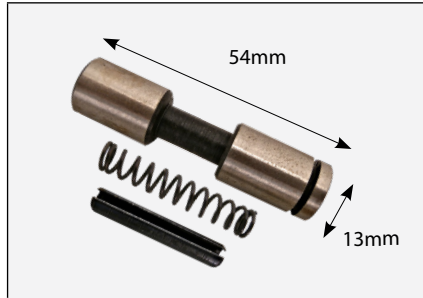

1456
PTO Release Button
13 x 54mm Flat Head

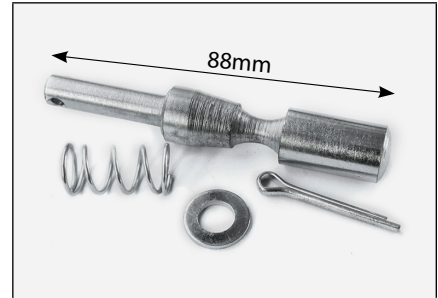

1440
PTO Release Y Pin



3147
Quick Release PTO Adaptor 1000 - 540
RPM 1 3/8" x 21 Splines & 1 3/8" x
6 Splines 1000 - 540 RPM



3071
Quick Release PTO Adaptor
1 3/8" x 6 Splines & 1 3/8" x 21 Splines



3146
Quick Release PTO Adaptor 540 - 540
RPM 1 3/8" x 6 Splines & 1 3/8" x
6 Splines 540 - 540 RPM



54361
PTO Adaptor Bolt Type 1 3/4 540 -
6 Spline 1 3/8 540 - 6 Spline



44066
PTO Adaptor With Grub Screw
Female 20 Spline 1 3/4"
Male 6 Spline 1 3/4"



54880
PTO Adaptor Female 6 Spline 1 3/8"
Male 6 Spline 1 3/8" Length 240mm

Tractor Mudguard Flaps

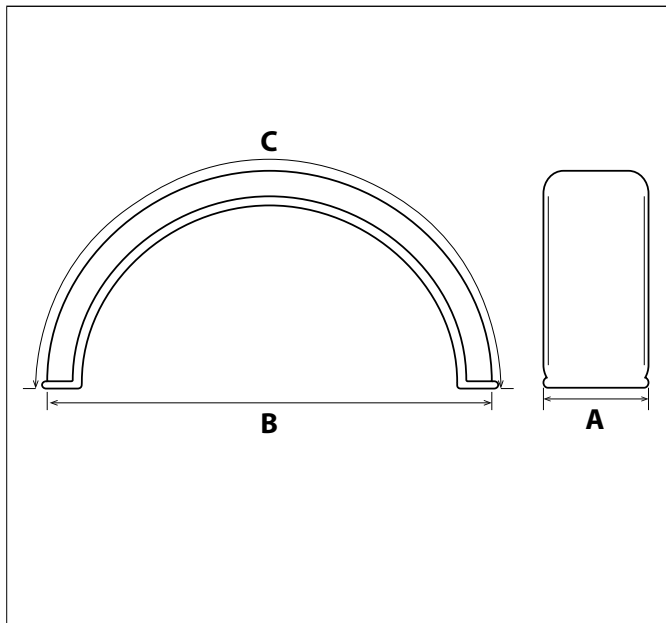

Note: All measurements are +/- 15mm due to the nature of manufacturing process

2436 - 2WD	A: 320 mm, B: 970mm	C: 1080 mm
2969	A: 350 mm, B: 970mm	C: 1090 mm
402947	A: 365 mm, B: 1135mm	C: 1280 mm
2968	A: 415 mm, B: 1235mm	C: 1430 mm
402948	A: 470 mm, B: 1250mm	C: 1440 mm
2959	A: 540mm, B: 1320mm	C: 1530 mm
2960	A: 605mm, B: 1630mm	C: 1895 mm
54823	A: 415mm, B: 1235mm	C: 1430 mm



54764
Mudguard Flap
Pre Drilled

SIZE

Width - 470mm
Length - 1250mm
Curve - 1440mm

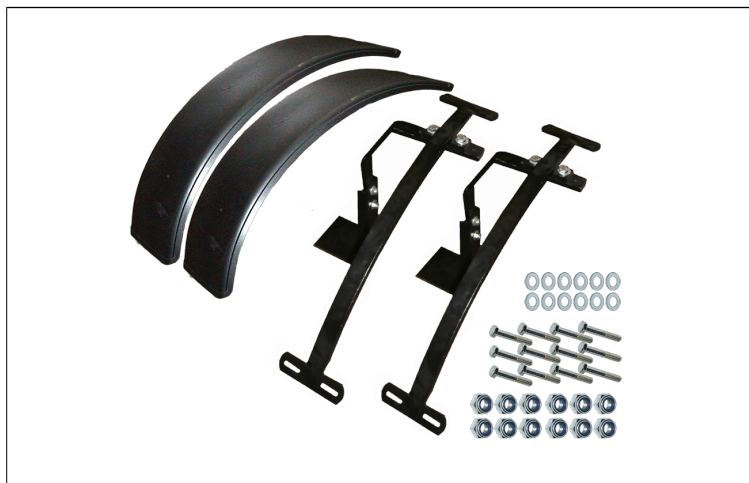

62811
Mudguard Kit Universal 4WD
400mm Flaps
63136 is Adaptor Plate



www.qtponline.com

www.qtponline.de

www.qtponline.fr

www.qtponline.es

> Find Parts

Find what you need quickly & easily

> Order Online 24/7

Shop online 24/7 with our web shop. Get prices and check availability on over 16,000 tractor spares

> New Products

New products & special offers

> Account Information

See previous orders, statements and stock information

Distributors of:

